

CF-RU1-8 IKO

Cam followers

TYPE: Roller bearings, Stud type track rollers, With axial guidance, gap seals on both side, centralized lubrication type (IKO)

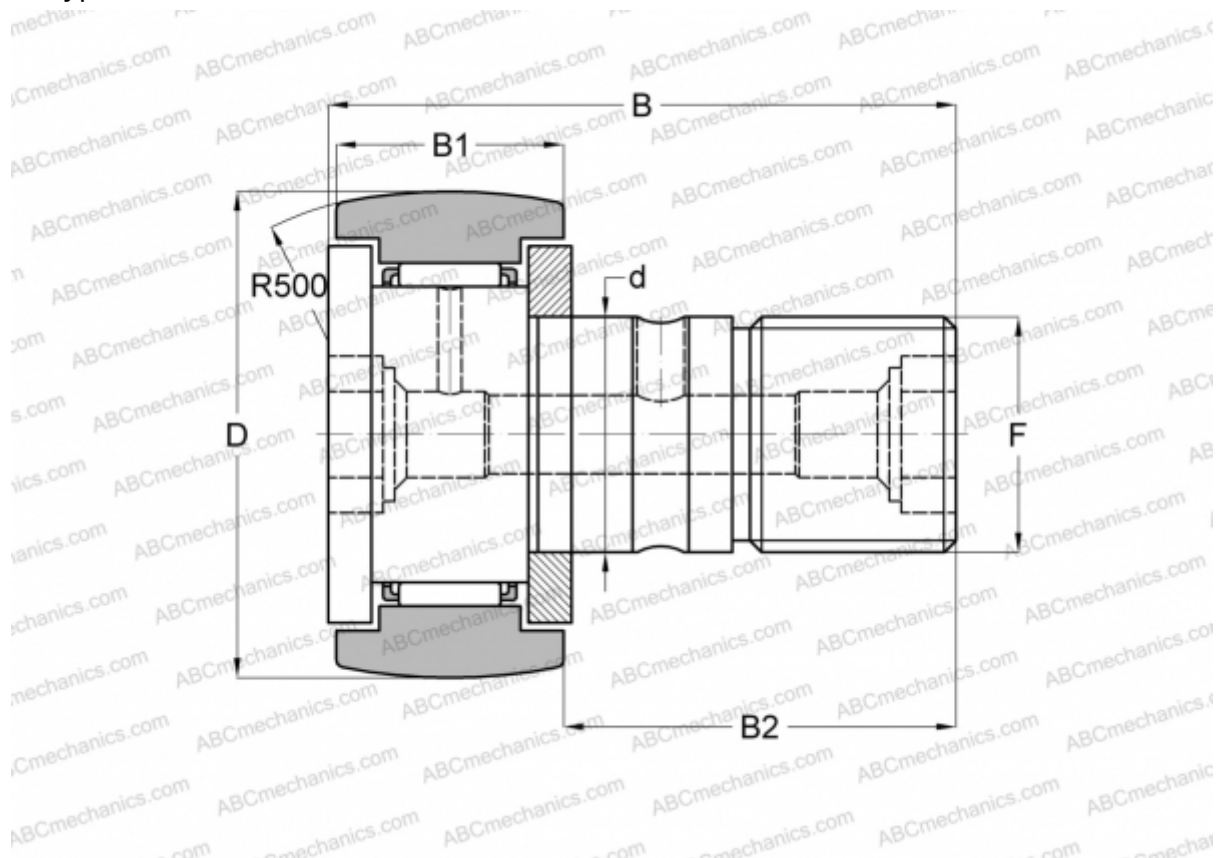

Technical specification

DIMENSIONS, MM

d	8,000
D	19,000
B	32,200
B1	11,000
B2	20,000
F	M8x1.25

WEIGHT, KG 0,029

MANUFACTURER [IKO](#)

CALCULATION DATA

Basic dynamic load rating, C	4,250 kN
Basic static load rating, Co	4,740 kN