

## CF-RU1-10-1 IKO

Cam followers

TYPE: Roller bearings, Stud type track rollers, With axial guidance, gap seals on both side, centralized lubrication type (IKO)

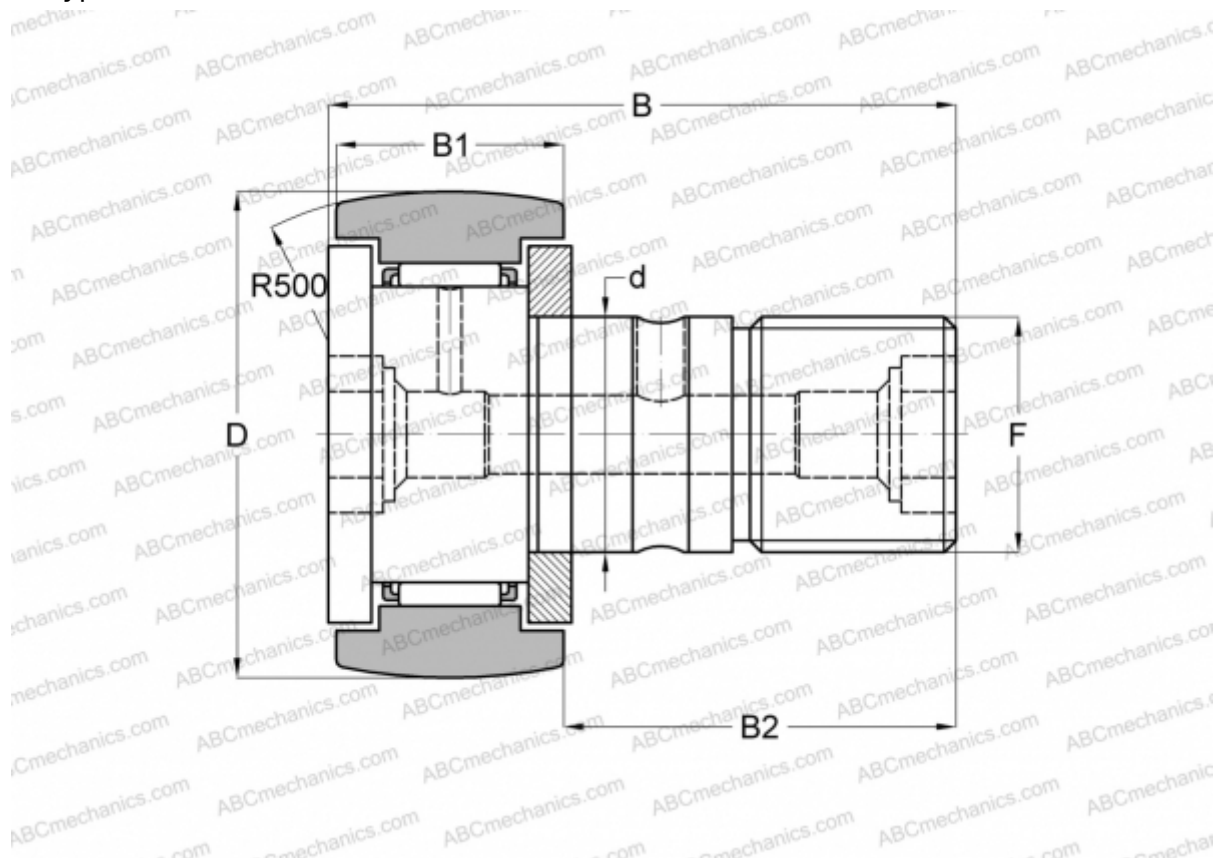

### Technical specification

#### DIMENSIONS, MM

d	10,000
D	26,000
B	36,200
B1	12,000
B2	23,000
F	M10x1.25

**WEIGHT, KG** 0,060

**MANUFACTURER** [IKO](#)

#### CALCULATION DATA

Basic dynamic load rating, C	5,430 kN
Basic static load rating, Co	6,890 kN