

CF-FU1-12 IKO

Cam followers

TYPE: Roller bearings, Stud type track rollers, With axial guidance, gap seals on both side, centralized lubrication type, cylindrical outer ring (IKO)

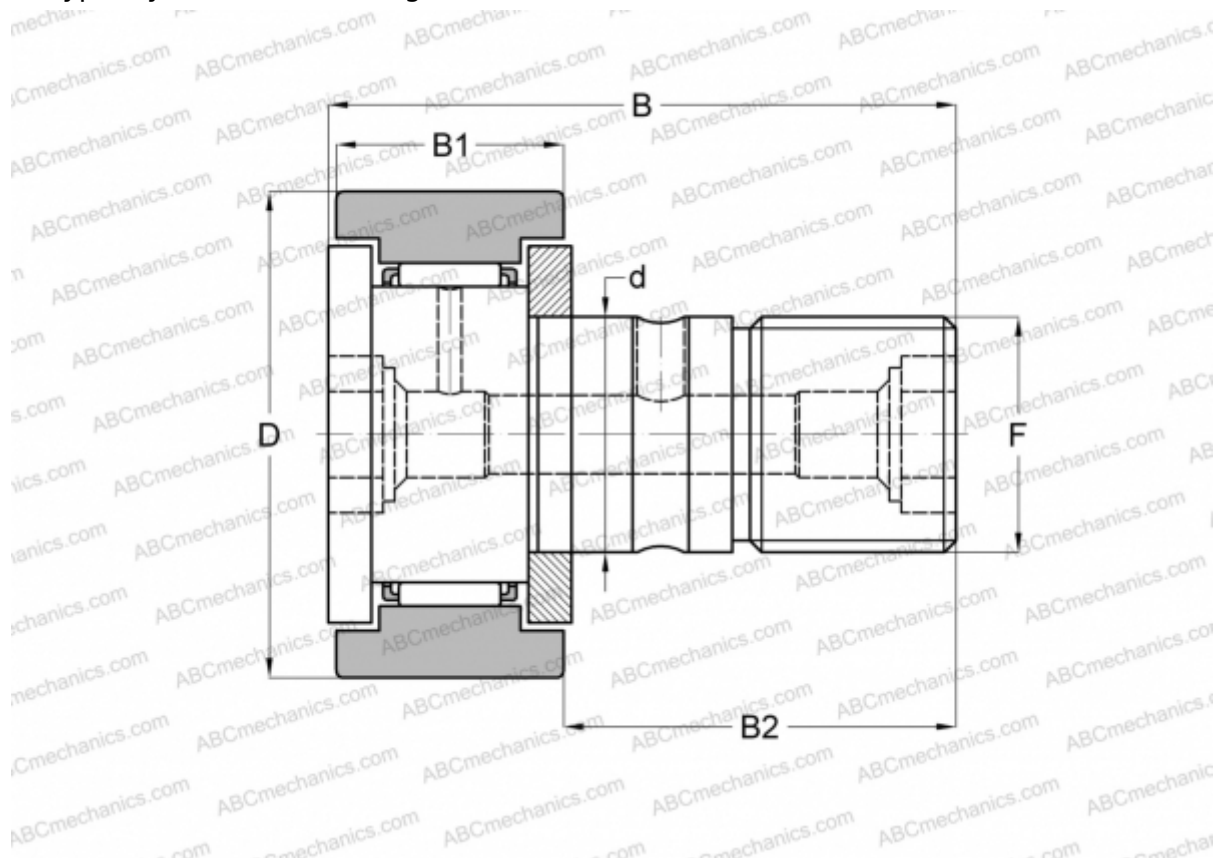

Technical specification

DIMENSIONS, MM

d	12,000
D	30,000
B	40,200
B1	14,000
B2	25,000
F	M12x1.5

WEIGHT, KG 0,095

MANUFACTURER [IKO](#)

CALCULATION DATA

Basic dynamic load rating, C	7,910 kN
Basic static load rating, Co	9,790 kN