

CF-FU1-18 IKO

Cam followers

TYPE: Roller bearings, Stud type track rollers, With axial guidance, gap seals on both side, centralized lubrication type, cylindrical outer ring (IKO)

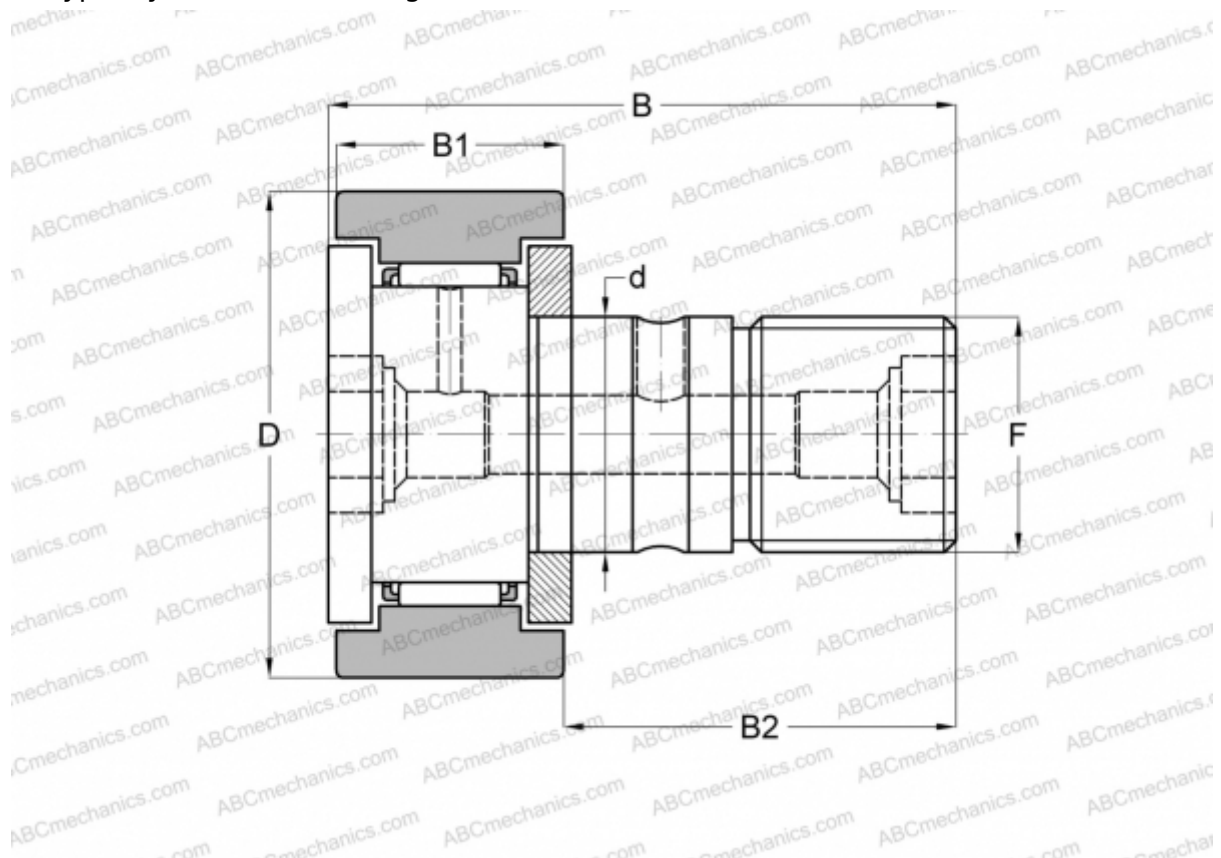

Technical specification

DIMENSIONS, MM

d	18,000
D	40,000
B	58,100
B1	20,000
B2	36,500
F	M18x1.5

WEIGHT, KG 0,250

MANUFACTURER [IKO](#)

CALCULATION DATA

Basic dynamic load rating, C	14,800 kN
Basic static load rating, Co	25,200 kN