

CF-FU1-24 IKO

Cam followers

TYPE: Roller bearings, Stud type track rollers, With axial guidance, gap seals on both side, centralized lubrication type, cylindrical outer ring (IKO)

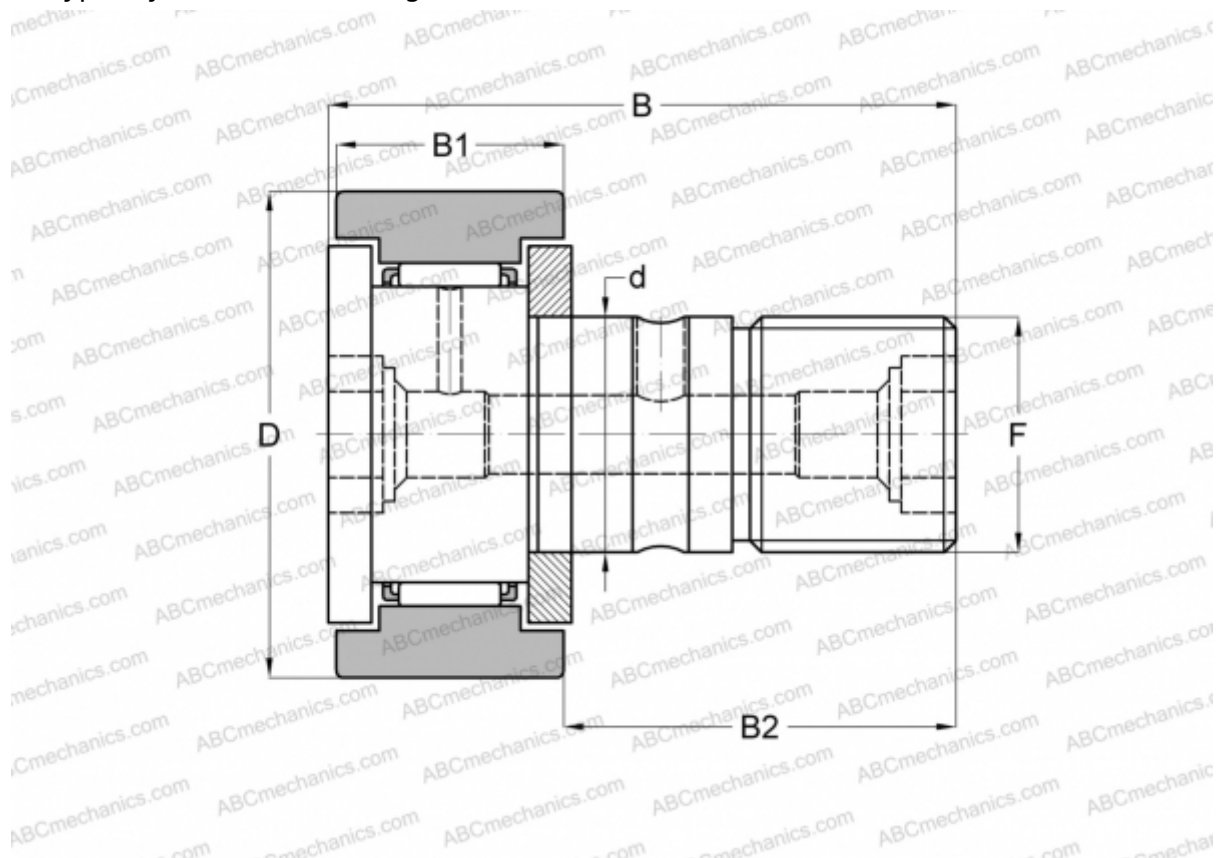

Technical specification

DIMENSIONS, MM

d	24,000
D	62,000
B	80,100
B1	29,000
B2	49,500
F	M24x1.5

WEIGHT, KG 0,815

MANUFACTURER [IKO](#)

CALCULATION DATA

Basic dynamic load rating, C	30,500 kN
Basic static load rating, Co	52,000 kN