

NUCF 12 R ABC

Cam followers

TYPE: Roller bearings, Stud type track rollers, With axial guidance, full complement cylindrical roller set, labyrinth seals on both sides

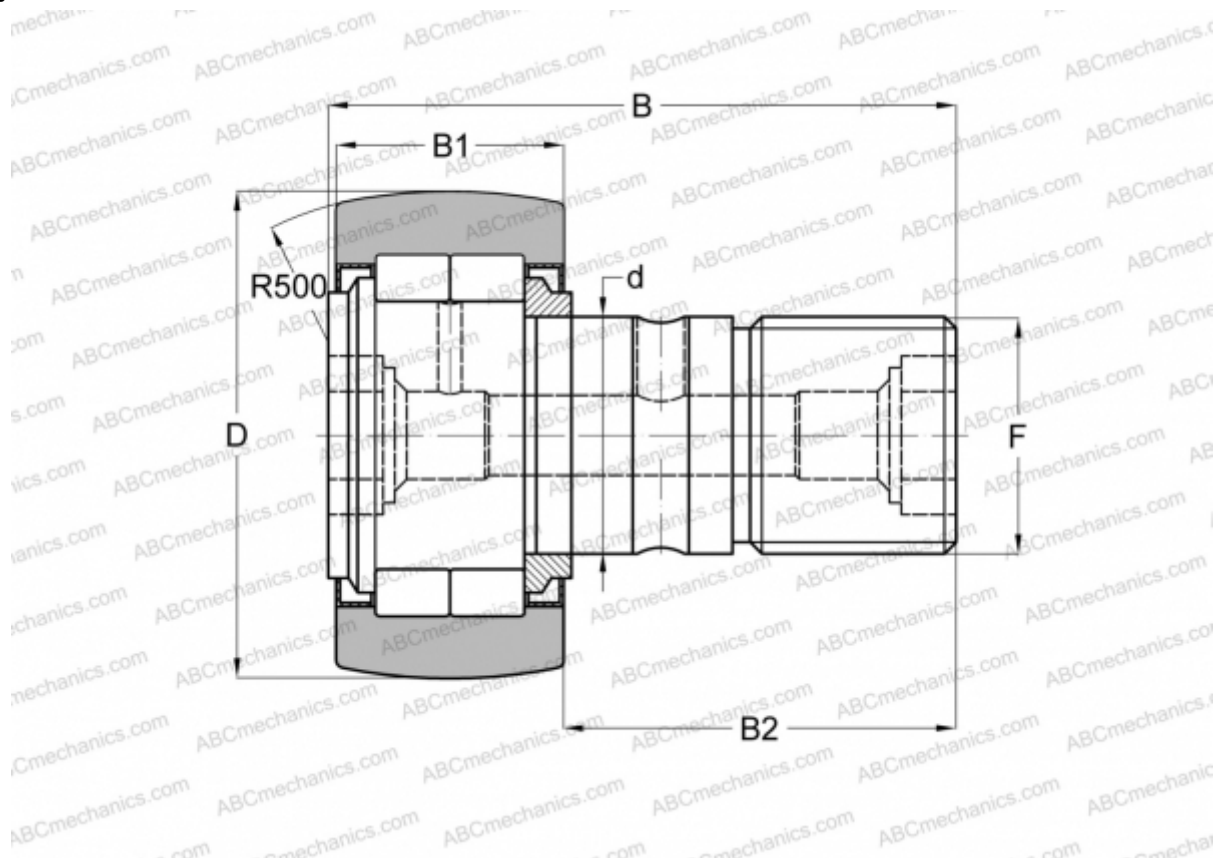

Technical specification

DIMENSIONS, MM

d	12,000
D	30,000
B	40,200
B1	14,000
B2	25,000
F	M12x1.5

WEIGHT, KG 0,086

MANUFACTURER [ABC](#)

INTERCHANGE

IKO [NUCF 12 R](#)