

NUKR 40 INA

Cam followers

TYPE: Roller bearings, Stud type track rollers, With axial guidance, full complement cylindrical roller set, labyrinth seals on both sides

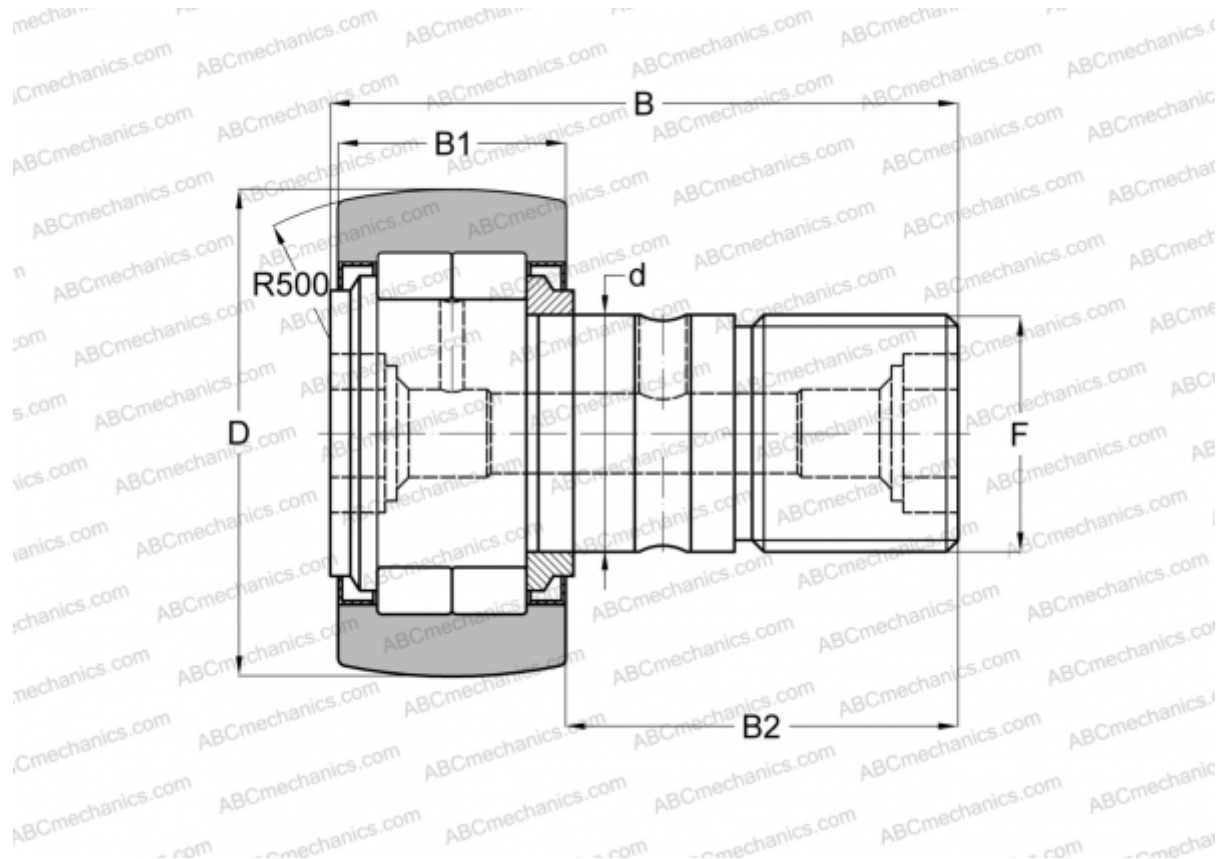

Technical specification

DIMENSIONS, MM

d	18,000
D	40,000
B	58,000
B1	20,000
B2	36,500
F	M18x1.5

WEIGHT, KG 0,254

MANUFACTURER [INA](#)

INTERCHANGE

ABC	NUKR 40
FAG	NUKR 40 C(NUKD 40)
IKO	NUCF 18 R
McGill	MCFD 40 S

INTERCHANGE

SKF [NUKR 40 A](#)