

NUKR 40 A SKF

Cam followers

TYPE: Roller bearings, Stud type track rollers, With axial guidance, full complement cylindrical roller set, labyrinth seals on both sides

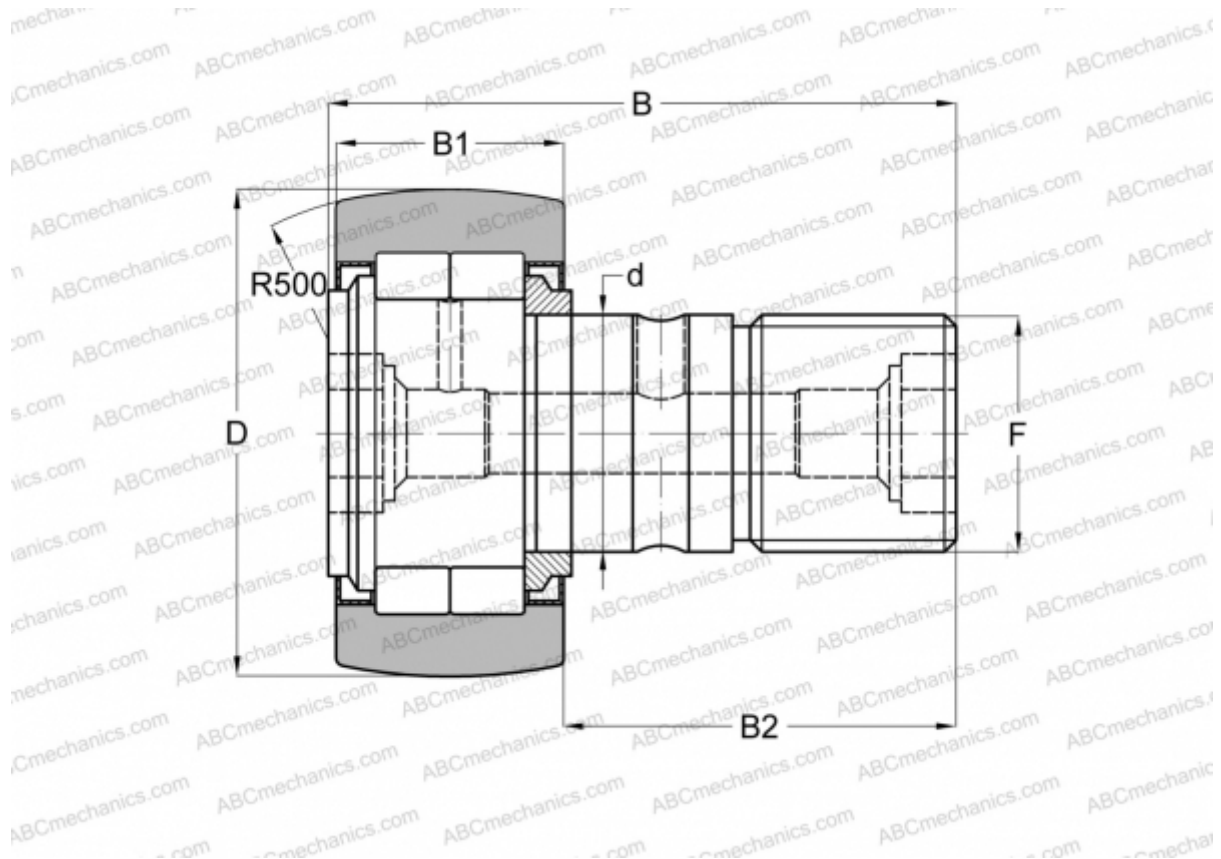

Technical specification

DIMENSIONS, MM

d	18,000
D	40,000
B	58,000
B1	20,000
B2	36,500
F	M 18x1.5

WEIGHT, KG 0,242

MANUFACTURER [SKF](#)

INTERCHANGE

ABC	NUKR 40
FAG	NUKR 40 C(NUKD 40)
INA	NUKR 40
IKO	NUCF 18 R

INTERCHANGE

McGill [MCFD 40 S](#)

CALCULATION DATA

Basic dynamic load rating, C	19,000 kN
Basic static load rating, Co	22,000 kN
Fatigue load limit, Pu	2,500 kN
Limiting speed	4500 r/min