

NUKR 47 C(NUKD 47) FAG

Cam followers

TYPE: Roller bearings, Stud type track rollers, With axial guidance, full complement cylindrical roller set, labyrinth seals on both sides

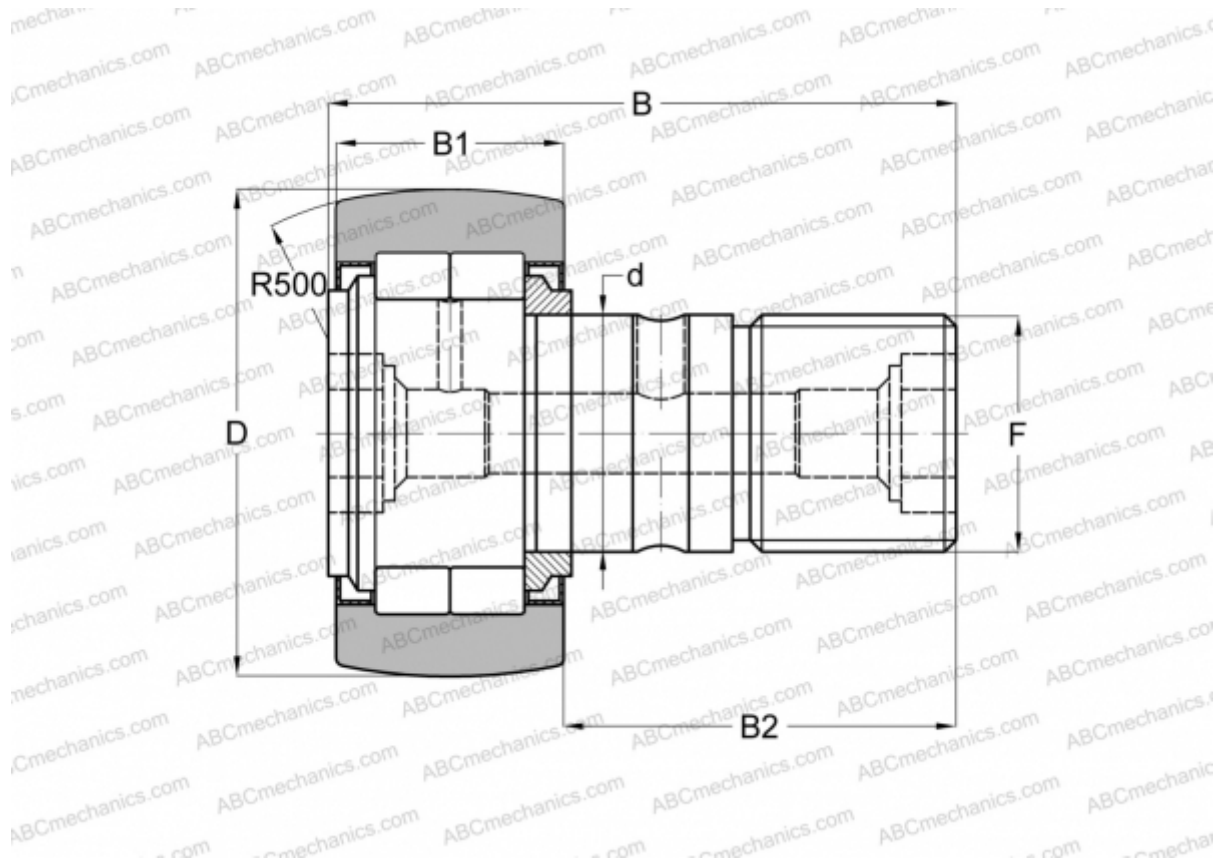

Technical specification

DIMENSIONS, MM

d	20,000
D	47,000
B	66,000
B1	24,000
B2	40,500
F	M20x1.5

WEIGHT, KG 0,390

MANUFACTURER [FAG](#)

INTERCHANGE

ABC	NUKR 47
INA	NUKR 47
IKO	NUCF 20-1 R
McGill	MCFD 47 S

INTERCHANGE

SKF [NUKR 47 A](#)