

NUKR 52 INA

Cam followers

TYPE: Roller bearings, Stud type track rollers, With axial guidance, full complement cylindrical roller set, labyrinth seals on both sides

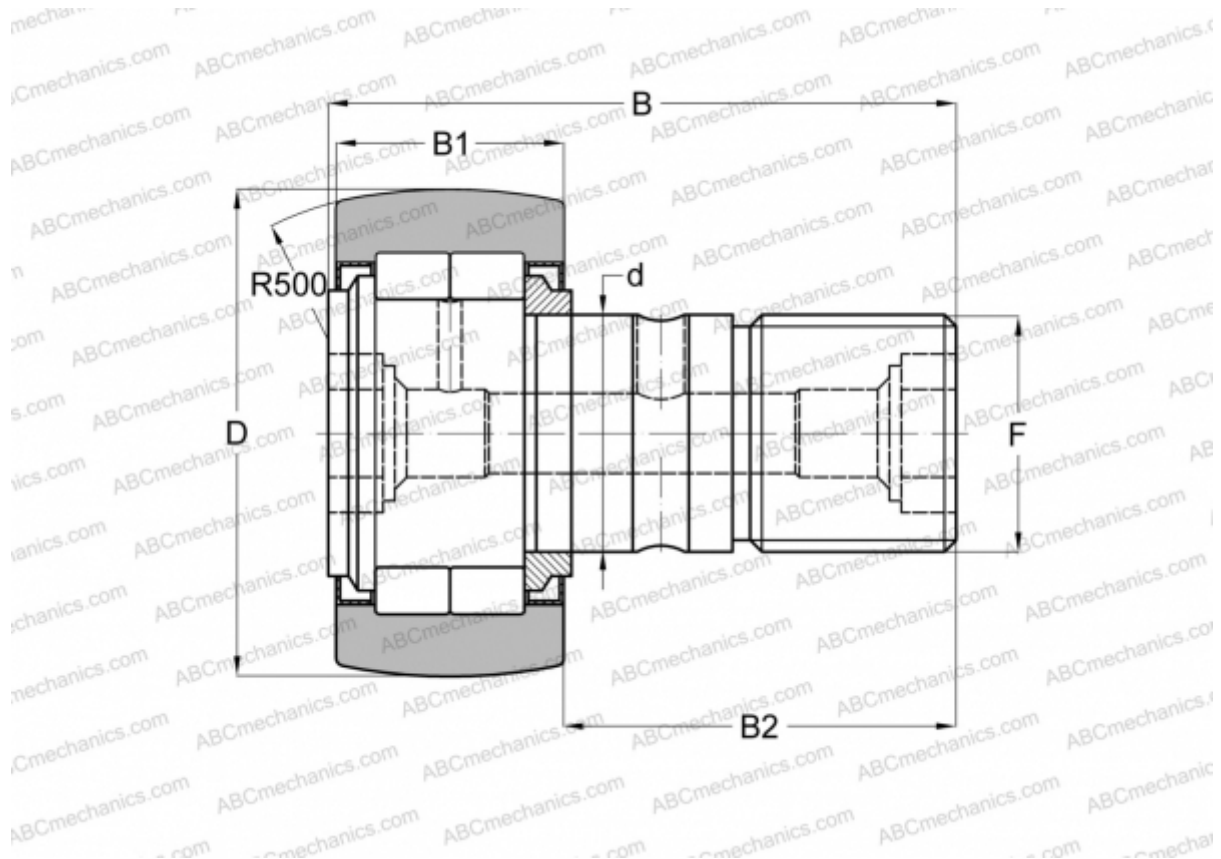

Technical specification

DIMENSIONS, MM

d	20,000
D	52,000
B	66,000
B1	24,000
B2	40,500
F	M20x1.5

WEIGHT, KG 0,463

MANUFACTURER [INA](#)

INTERCHANGE

ABC	NUKR 52
FAG	NUKR 52 C(NUKD 52)
IKO	NUCF 20 R
McGill	MCFD 52 S

INTERCHANGE

SKF [NUKR 52 A](#)