

## NUKR 62 C(NUKD 62) FAG

Cam followers

TYPE: Roller bearings, Stud type track rollers, With axial guidance, full complement cylindrical roller set, labyrinth seals on both sides

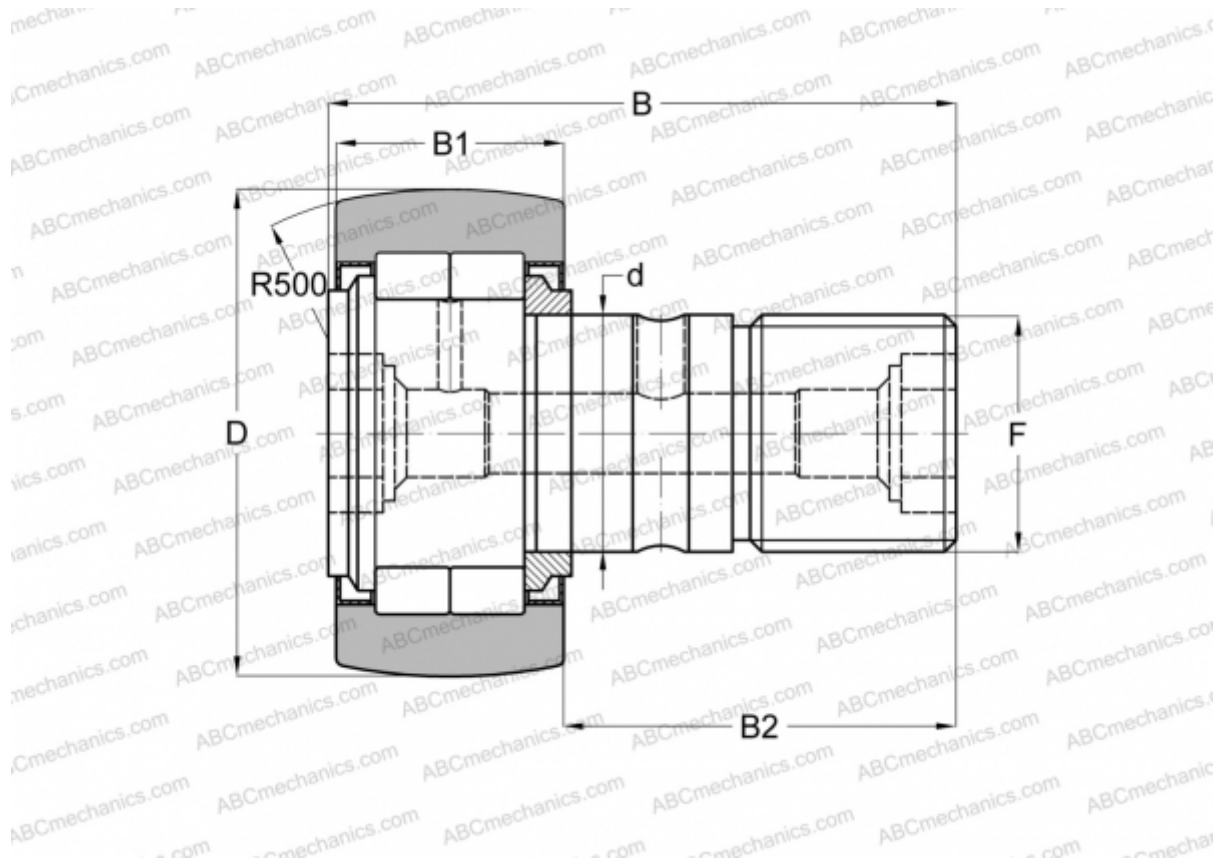

### Technical specification

#### DIMENSIONS, MM

d	24,000
D	62,000
B	80,000
B1	29,000
B2	49,500
F	M24x1.5

**WEIGHT, KG** 0,794

**MANUFACTURER** [FAG](#)

#### INTERCHANGE

ABC	<a href="#">NUKR 62</a>
INA	<a href="#">NUKR 62</a>
IKO	<a href="#">NUCF 24 R</a>
McGill	<a href="#">MCFD 62 S</a>

#### INTERCHANGE

SKF [NUKR 62 A](#)