

MCFD 62 S McGill

Cam followers

TYPE: Roller bearings, Stud type track rollers, With axial guidance, full complement cylindrical roller set, labyrinth seals on both sides

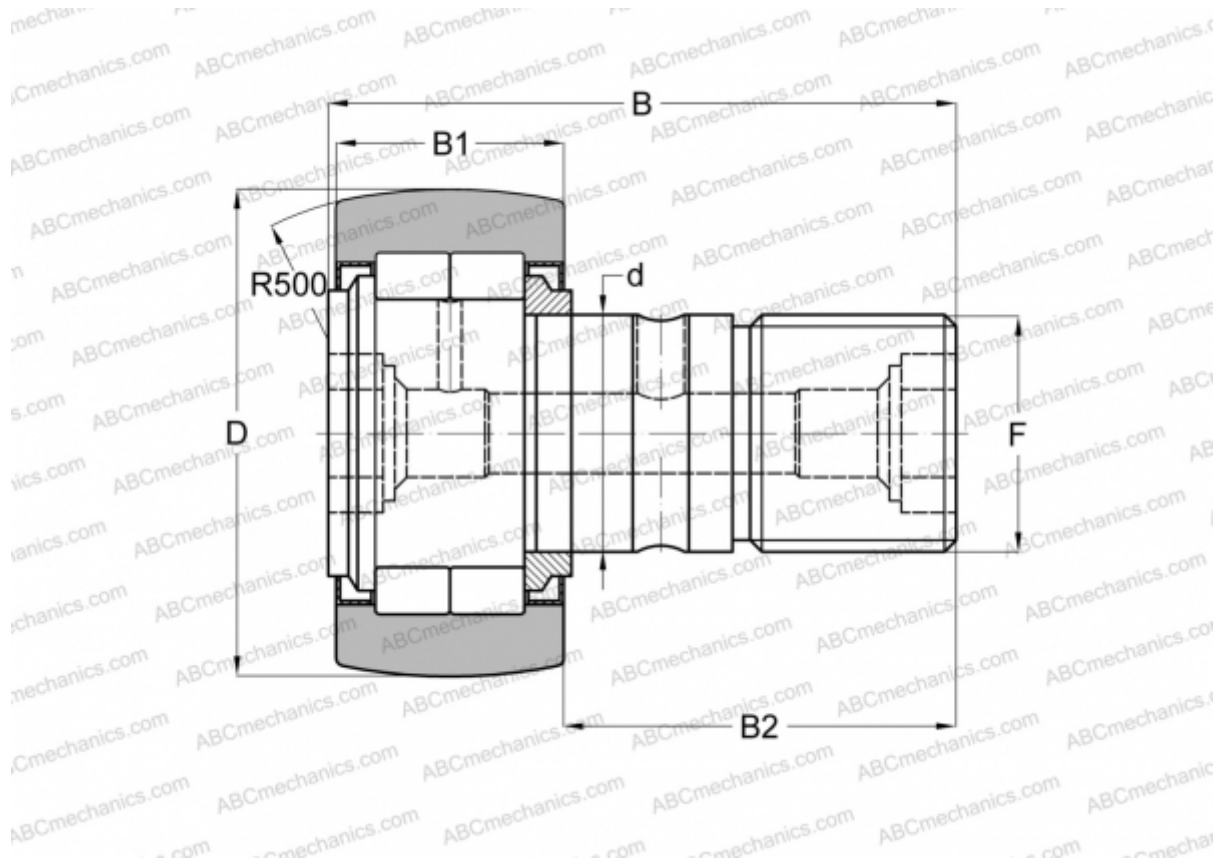

Technical specification

DIMENSIONS, MM

d	24,000
D	62,000
B	80,000
B1	29,000
B2	49,500
F	M24x1.5

WEIGHT, KG 0,794

MANUFACTURER [McGill](#)

INTERCHANGE

ABC	NUKR 62
FAG	NUKR 62 C(NUKD 62)
INA	NUKR 62
IKO	NUCF 24 R

INTERCHANGE

SKF [NUKR 62 A](#)