

NUKR 72 ABC

Cam followers

TYPE: Roller bearings, Stud type track rollers, With axial guidance, full complement cylindrical roller set, labyrinth seals on both sides

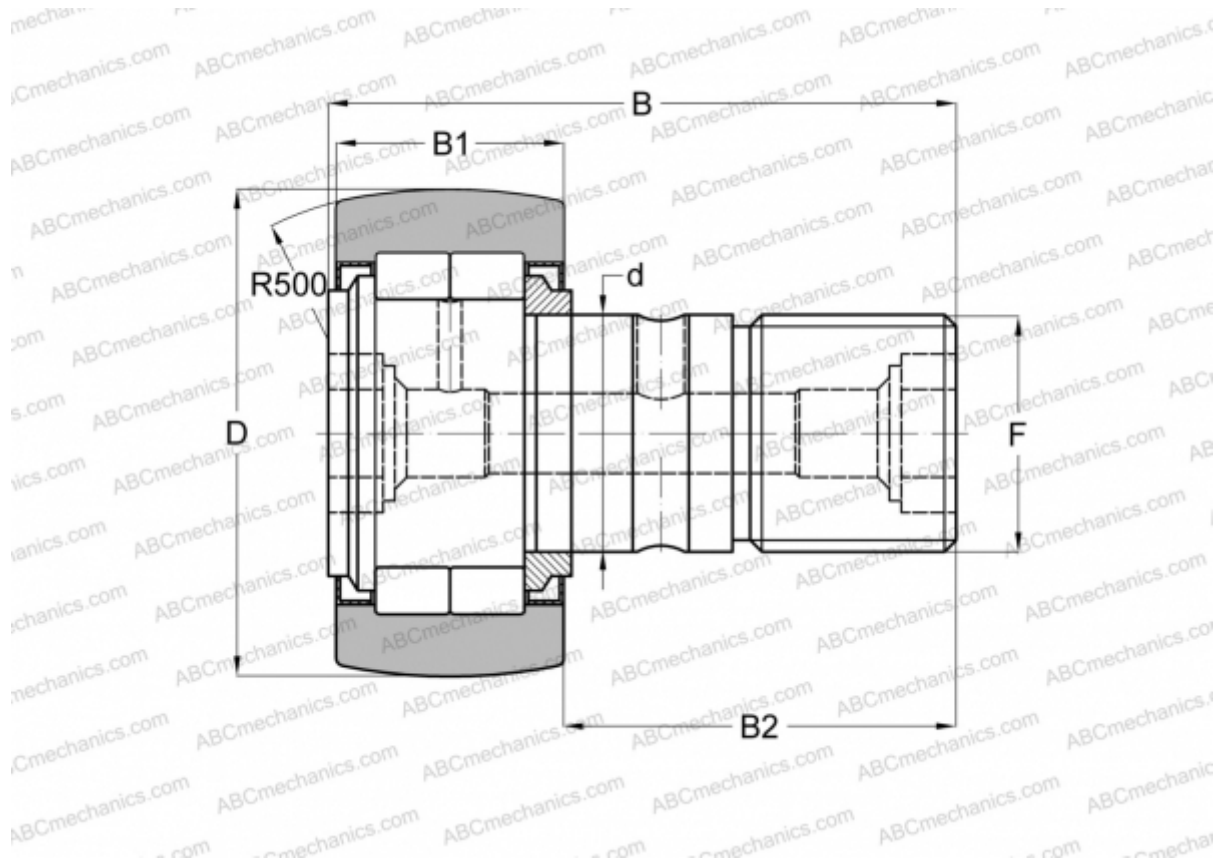

Technical specification

DIMENSIONS, MM

d	24,000
D	72,000
B	80,000
B1	29,000
B2	49,500
F	M24x1.5

WEIGHT, KG 1,043

MANUFACTURER [ABC](#)

INTERCHANGE

FAG	NUKR 72 C(NUKD 72)
INA	NUKR 72
IKO	NUCF 24-1 R
McGill	MCFD 72 S

INTERCHANGE

SKF [NUKR 72 A](#)