

NUKR 72 A SKF

Cam followers

TYPE: Roller bearings, Stud type track rollers, With axial guidance, full complement cylindrical roller set, labyrinth seals on both sides

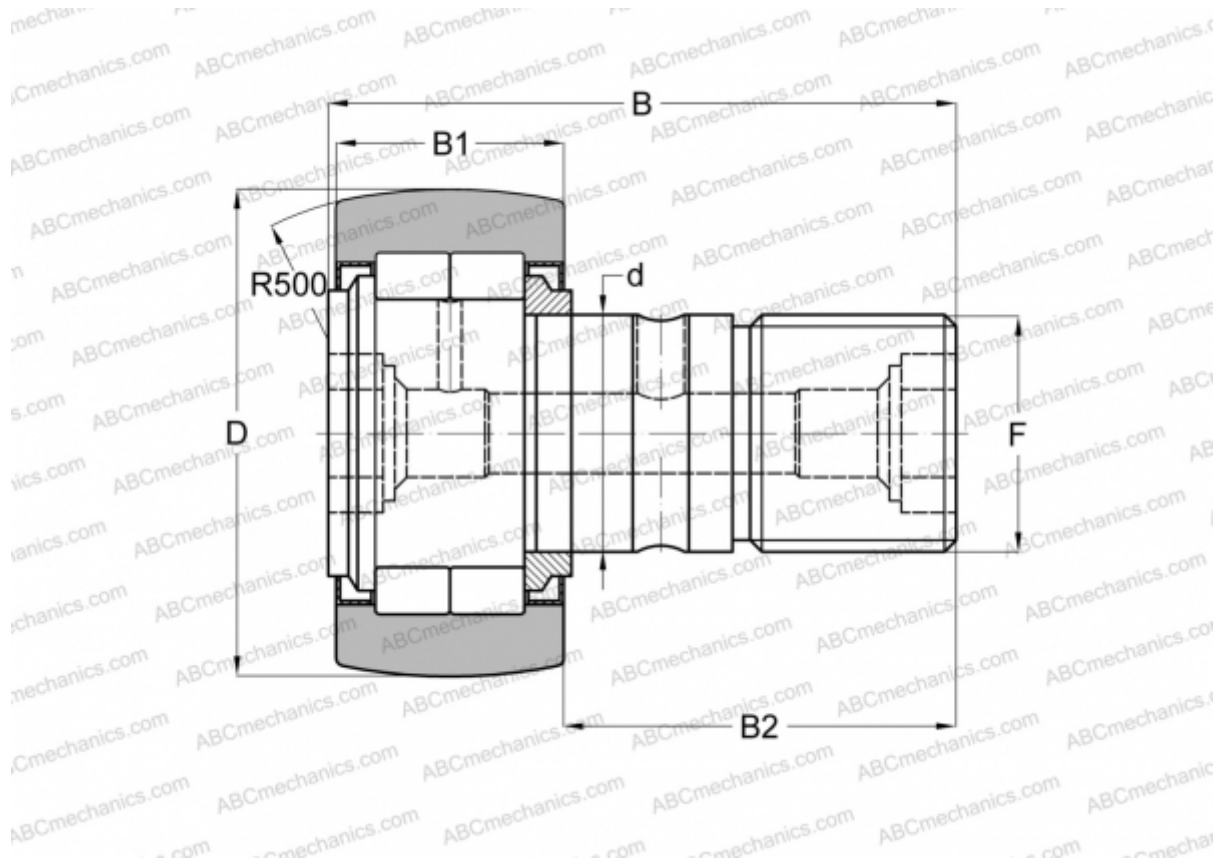

Technical specification

DIMENSIONS, MM

d	24,000
D	72,000
B	80,000
B1	28,000
B2	49,500
F	M 24x1.5

WEIGHT, KG 1,020

MANUFACTURER [SKF](#)

INTERCHANGE

ABC	NUKR 72
FAG	NUKR 72 C(NUKD 72)
INA	NUKR 72
IKO	NUCF 24-1 R

INTERCHANGE

McGill [MCFD 72 S](#)

CALCULATION DATA

Basic dynamic load rating, C	45,700 kN
Basic static load rating, Co	58,500 kN
Fatigue load limit, Pu	7,100 kN
Limiting speed	2000 r/min