

CF 5 WBUUR/SG IKO

Cam followers

TYPE: Roller bearings, Stud type track rollers, With axial guidance, sealing rings on both sides, thermosetting solid-type lubricant C-Lube (IKO)

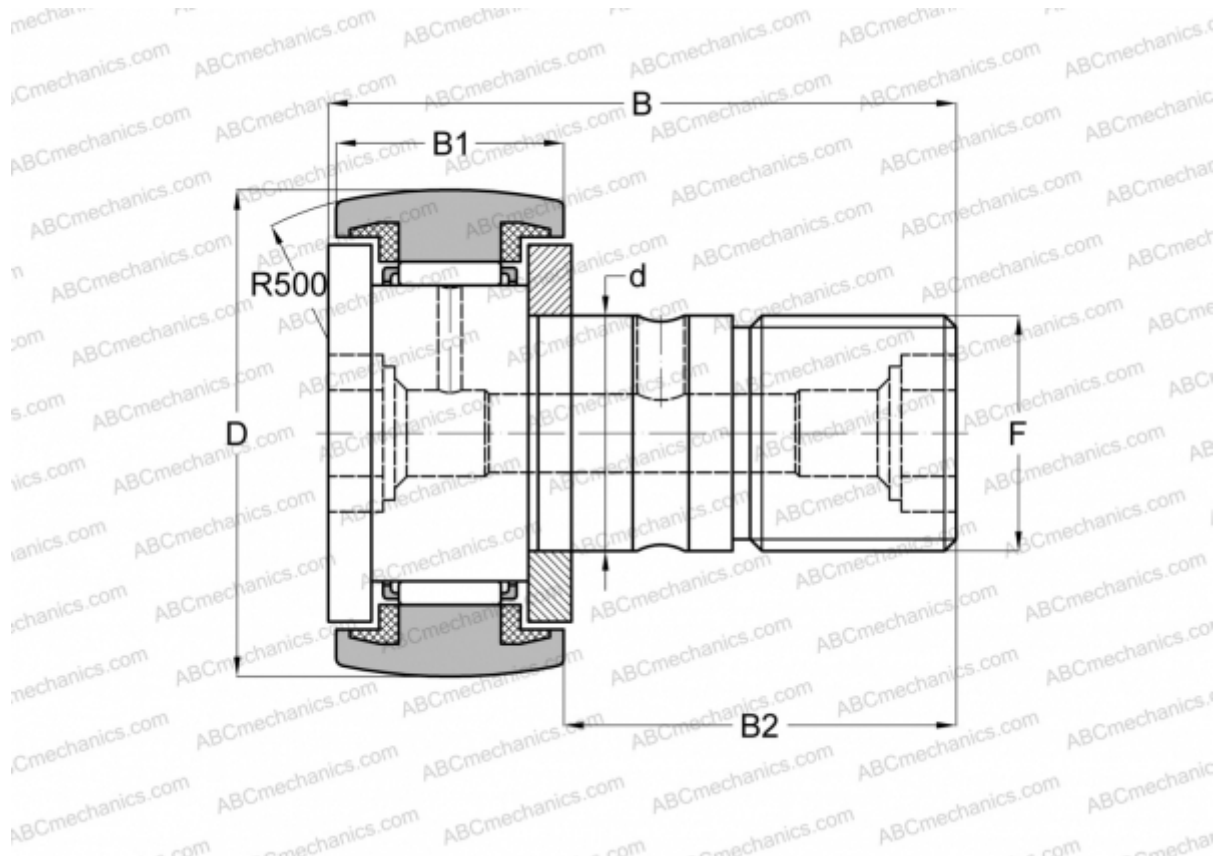

Technical specification

DIMENSIONS, MM

d	5,000
D	13,000
B	23,000
B1	9,000
B2	13,000
F	M5x0.8

WEIGHT, KG 0,010

MANUFACTURER [IKO](#)

CALCULATION DATA

Basic dynamic load rating, C	2,520 kN
Basic static load rating, Co	2,140 kN