

CF 16 WBUUR/SG IKO

Cam followers

TYPE: Roller bearings, Stud type track rollers, With axial guidance, sealing rings on both sides, thermosetting solid-type lubricant C-Lube (IKO)

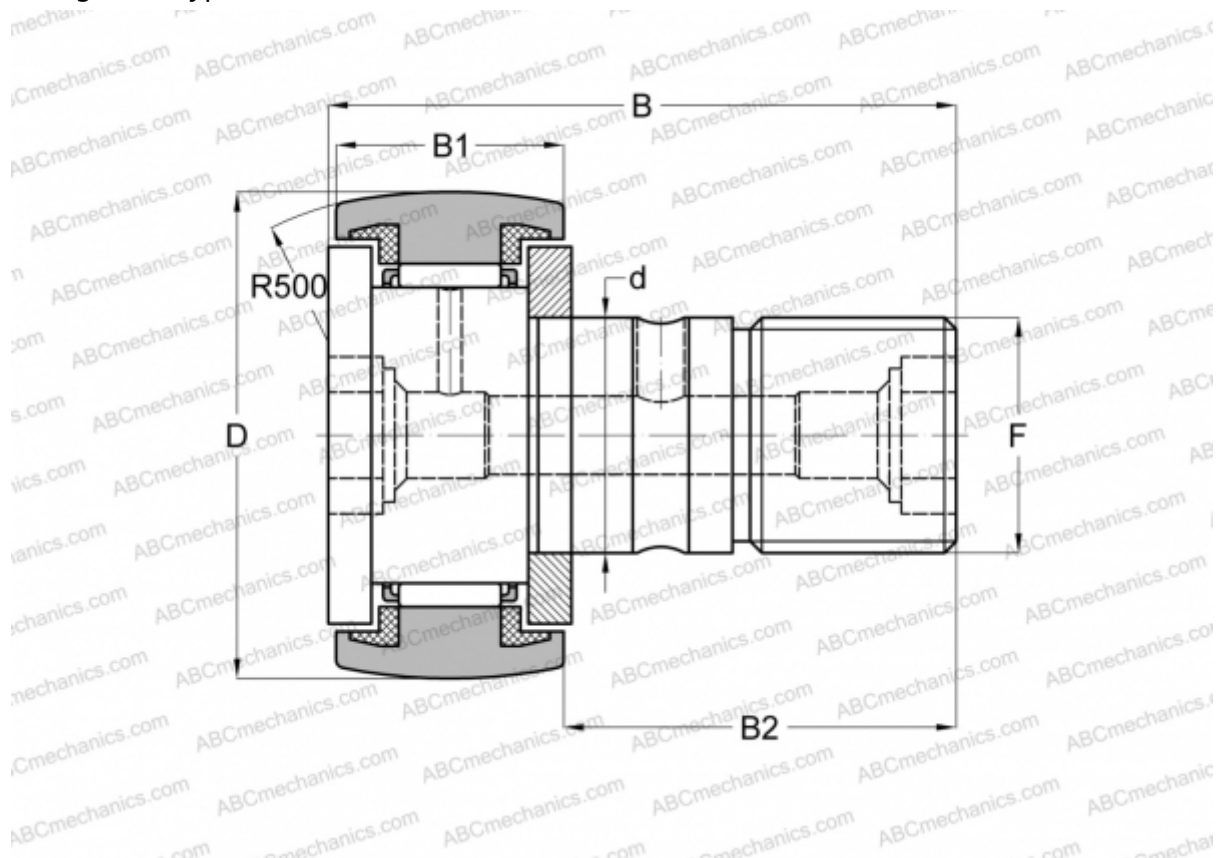

Technical specification

DIMENSIONS, MM

d	16,000
D	35,000
B	52,100
B1	18,000
B2	32,500
F	M16x1.5

WEIGHT, KG 0,170

MANUFACTURER [IKO](#)

CALCULATION DATA

Basic dynamic load rating, C	12,000 kN
Basic static load rating, Co	18,300 kN