

CR 12 BR IKO

Cam followers

TYPE: Roller bearings, Stud type track rollers, With axial guidance, gap seals on both side, hex hole, inch size (IKO)

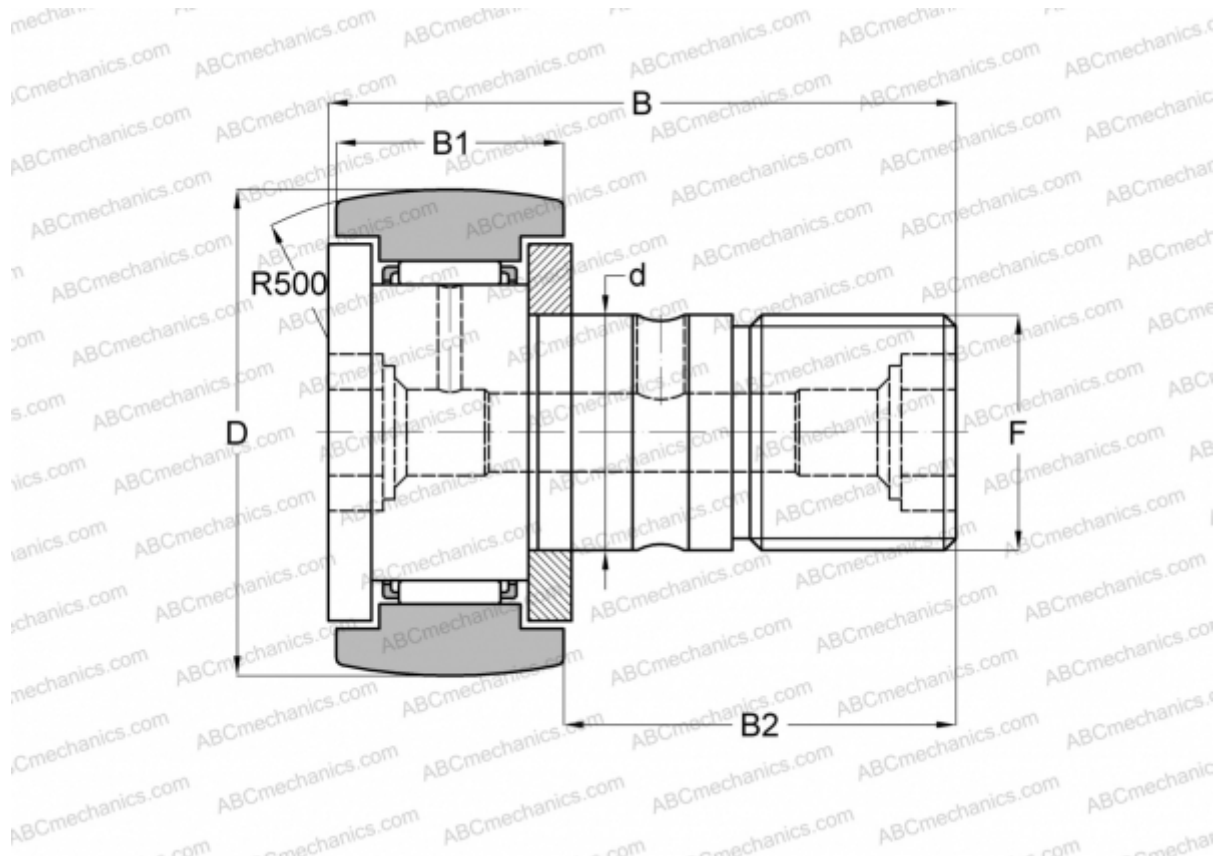

Technical specification

DIMENSIONS, MM

d	9,525
D	19,050
B	35,719
B1	13,494
B2	22,225
F	3/8-24

WEIGHT, KG 0,035

MANUFACTURER [IKO](#)

CALCULATION DATA

Basic dynamic load rating, C	4,420 kN
Basic static load rating, Co	5,110 kN