

CR 20 BR IKO

Cam followers

TYPE: Roller bearings, Stud type track rollers, With axial guidance, gap seals on both side, hex hole, inch size (IKO)

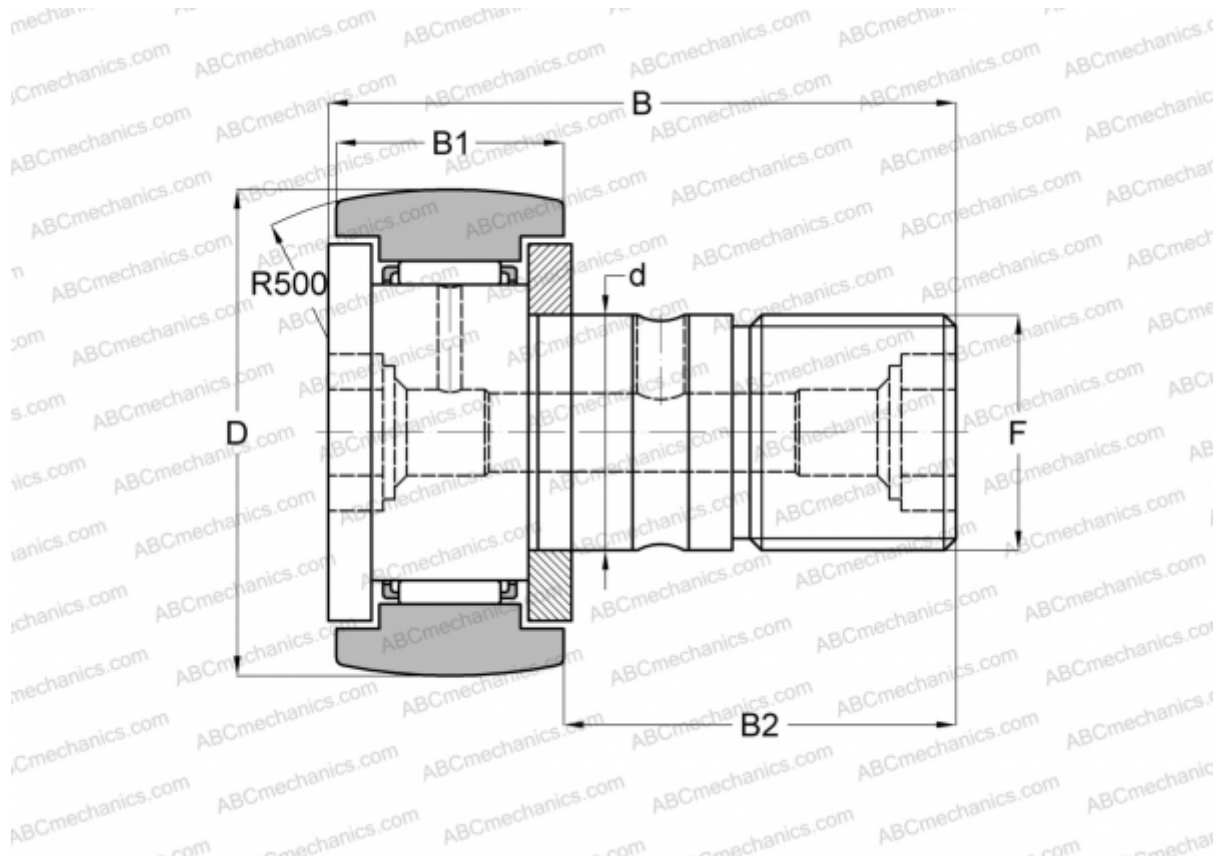

Technical specification

DIMENSIONS, MM

d	12,700
D	31,750
B	51,594
B1	19,844
B2	31,750
F	1/2-20

WEIGHT, KG 0,132

MANUFACTURER [IKO](#)

CALCULATION DATA

Basic dynamic load rating, C	14,200 kN
Basic static load rating, Co	16,000 kN