

CR 24 BR IKO

Cam followers

TYPE: Roller bearings, Stud type track rollers, With axial guidance, gap seals on both side, hex hole, inch size (IKO)

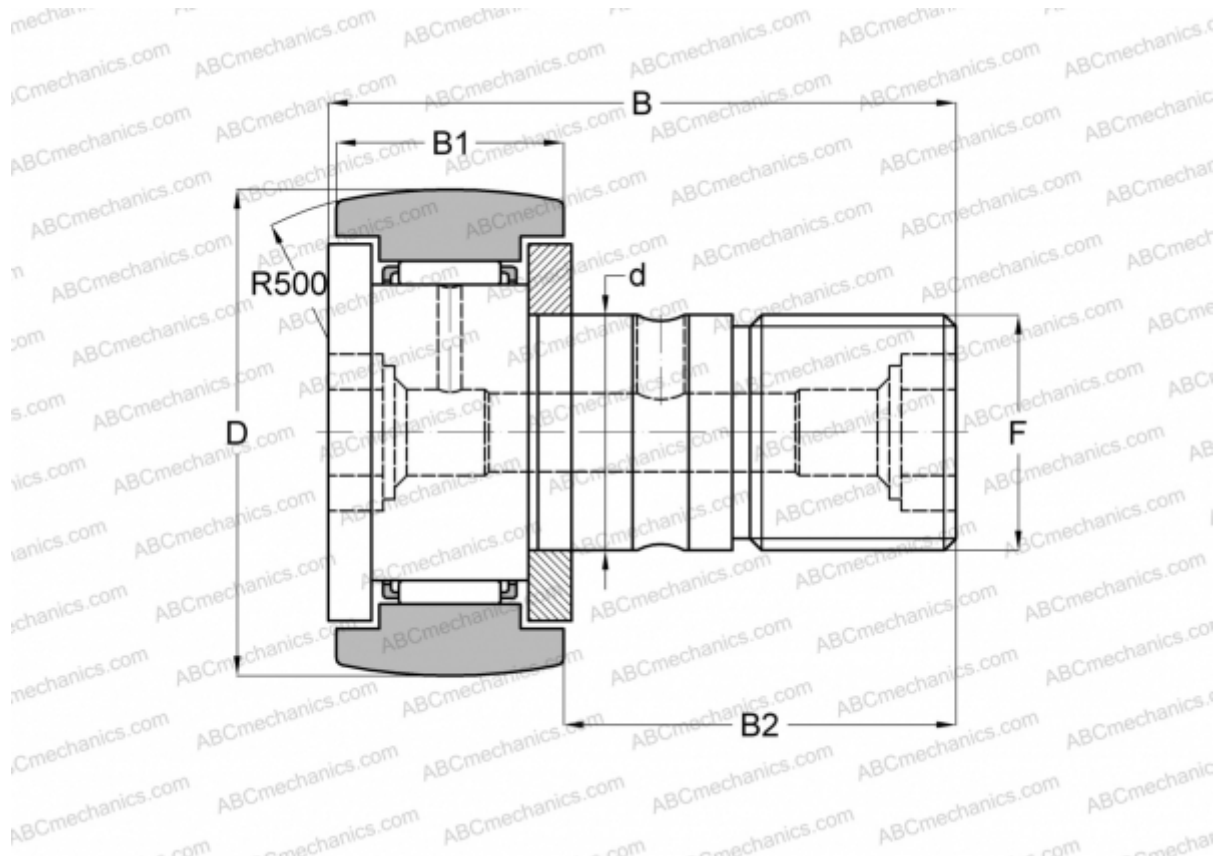

Technical specification

DIMENSIONS, MM

d	15,875
D	38,100
B	61,119
B1	23,019
B2	38,100
F	5/8-18

WEIGHT, KG 0,225

MANUFACTURER [IKO](#)

CALCULATION DATA

Basic dynamic load rating, C	18,600 kN
Basic static load rating, Co	24,300 kN