

CR 30 BR IKO

Cam followers

TYPE: Roller bearings, Stud type track rollers, With axial guidance, gap seals on both side, hex hole, inch size (IKO)

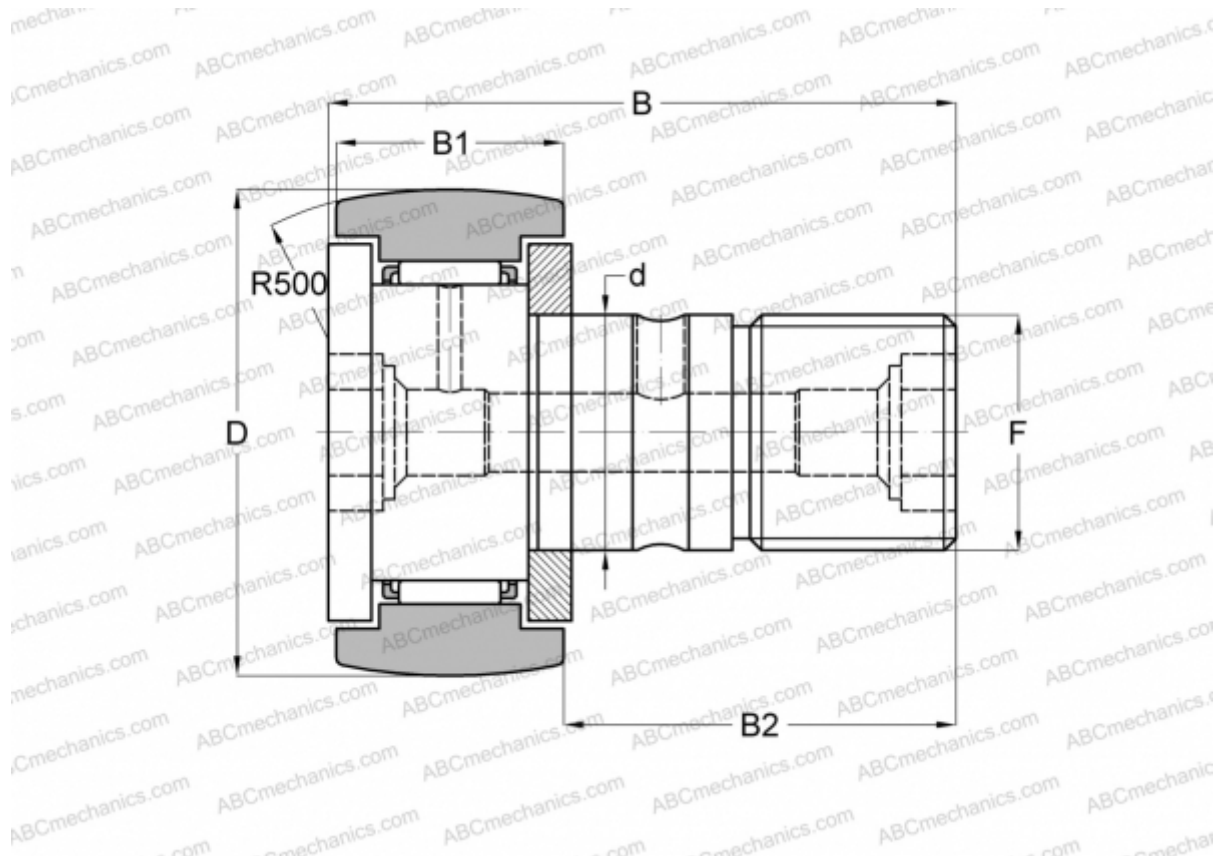

Technical specification

DIMENSIONS, MM

d	19,050
D	47,625
B	70,644
B1	26,194
B2	44,450
F	3/4-16

WEIGHT, KG 0,410

MANUFACTURER [IKO](#)

CALCULATION DATA

Basic dynamic load rating, C	25,100 kN
Basic static load rating, Co	38,200 kN