

## CR 10 B IKO

Cam followers

TYPE: Roller bearings, Stud type track rollers, With axial guidance, gap seals on both side, cylindrical outer ring, hex hole, inch size (IKO)

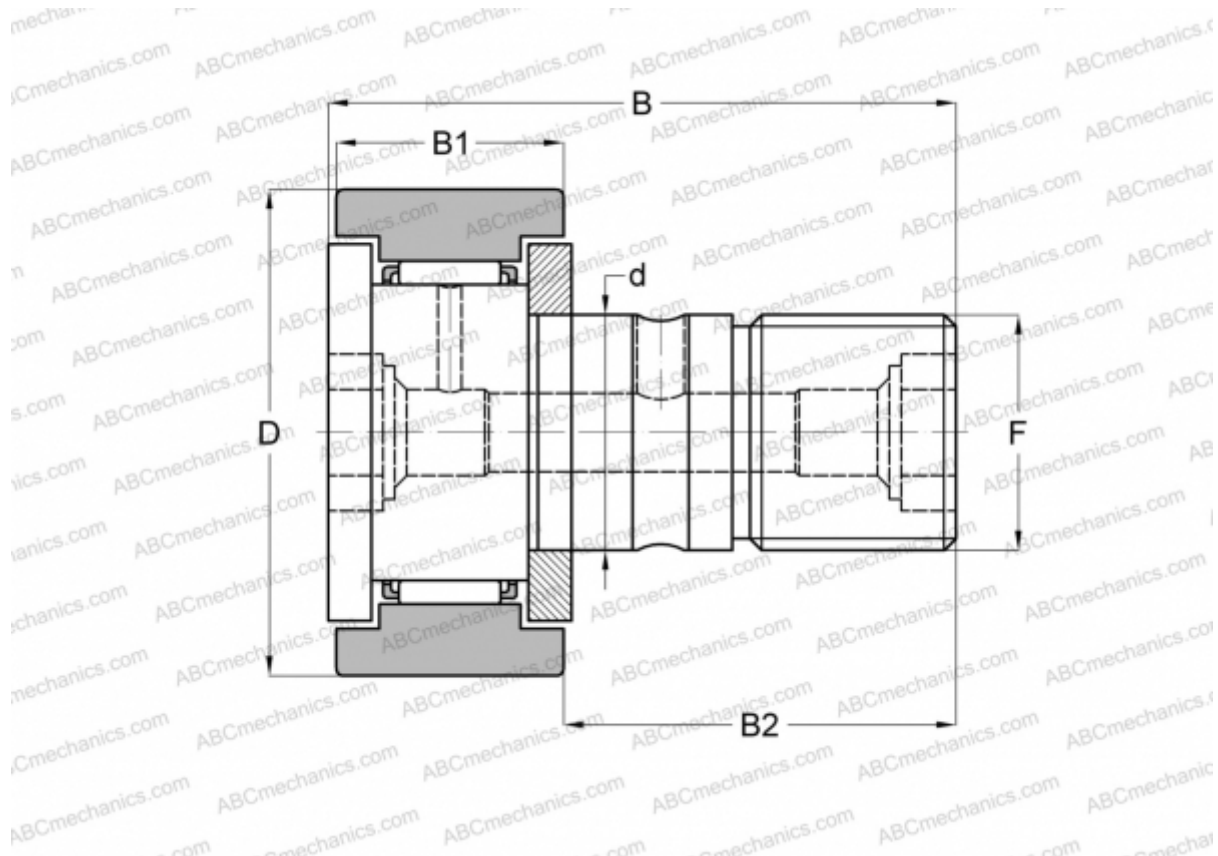

### Technical specification

#### DIMENSIONS, MM

d	6,350
D	15,875
B	26,987
B1	11,112
B2	15,875
F	1/4-28

**WEIGHT, KG** 0,019

**MANUFACTURER** [IKO](#)

#### CALCULATION DATA

Basic dynamic load rating, C	3,650 kN
Basic static load rating, Co	3,670 kN