

## CR 12 B IKO

Cam followers

TYPE: Roller bearings, Stud type track rollers, With axial guidance, gap seals on both side, cylindrical outer ring, hex hole, inch size (IKO)

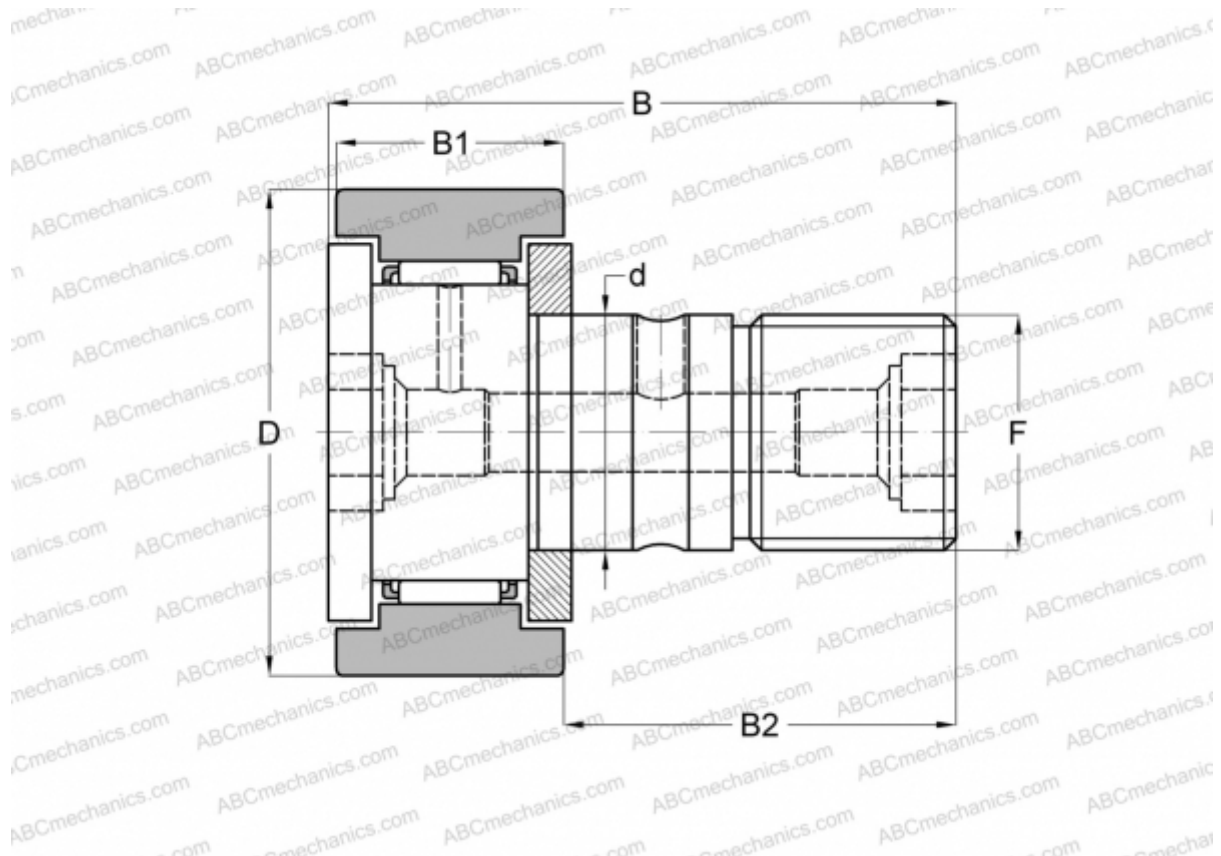

### Technical specification

#### DIMENSIONS, MM

d	9,525
D	19,050
B	35,719
B1	13,494
B2	22,225
F	3/8-24

**WEIGHT, KG** 0,035

**MANUFACTURER** [IKO](#)

#### CALCULATION DATA

Basic dynamic load rating, C	4,420 kN
Basic static load rating, Co	5,110 kN