

CR 32 B IKO

Cam followers

TYPE: Roller bearings, Stud type track rollers, With axial guidance, gap seals on both side, cylindrical outer ring, hex hole, inch size (IKO)

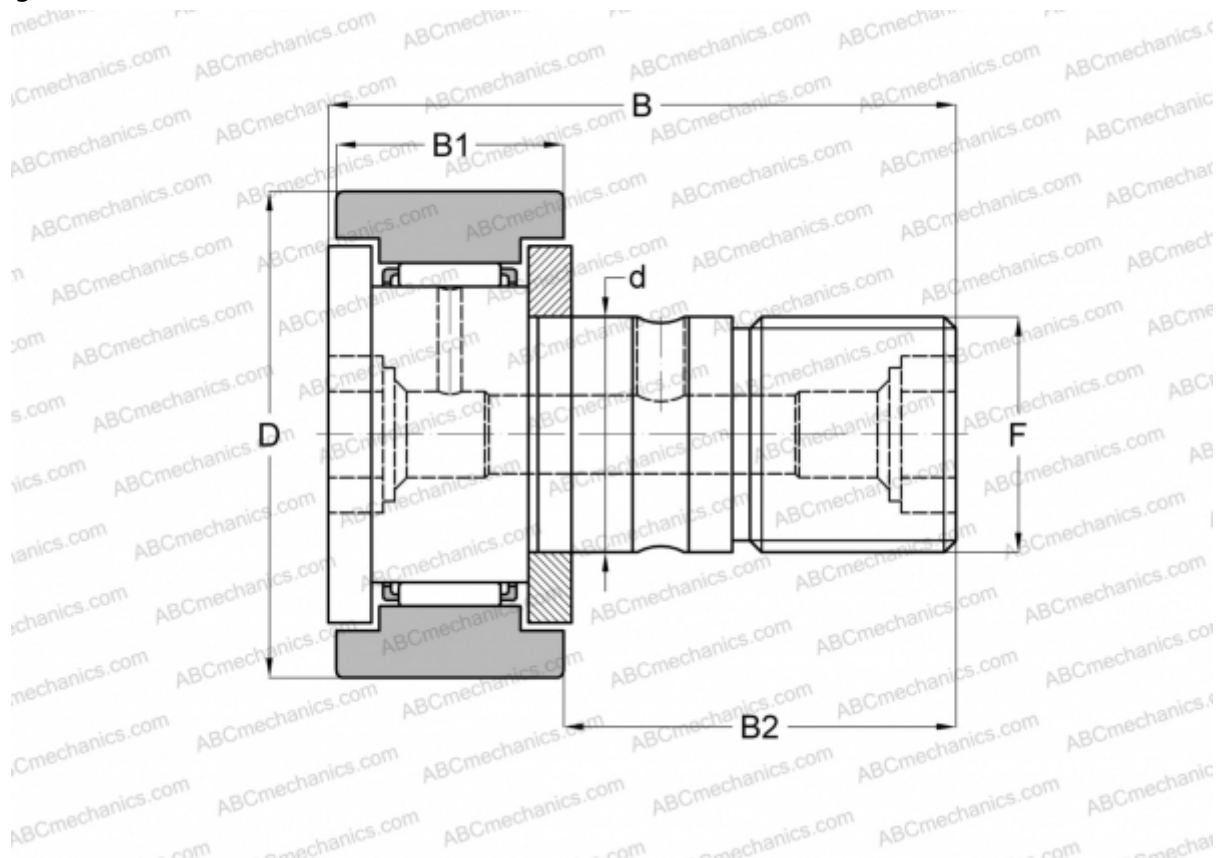

Technical specification

DIMENSIONS, MM

d	22,225
D	50,800
B	83,344
B1	32,544
B2	50,800
F	7/8-14

WEIGHT, KG 0,615

MANUFACTURER [IKO](#)

CALCULATION DATA

Basic dynamic load rating, C	32,500 kN
Basic static load rating, Co	63,900 kN