

CR 16 R IKO

Cam followers

TYPE: Roller bearings, Stud type track rollers, With axial guidance, gap seals on both side, inch size

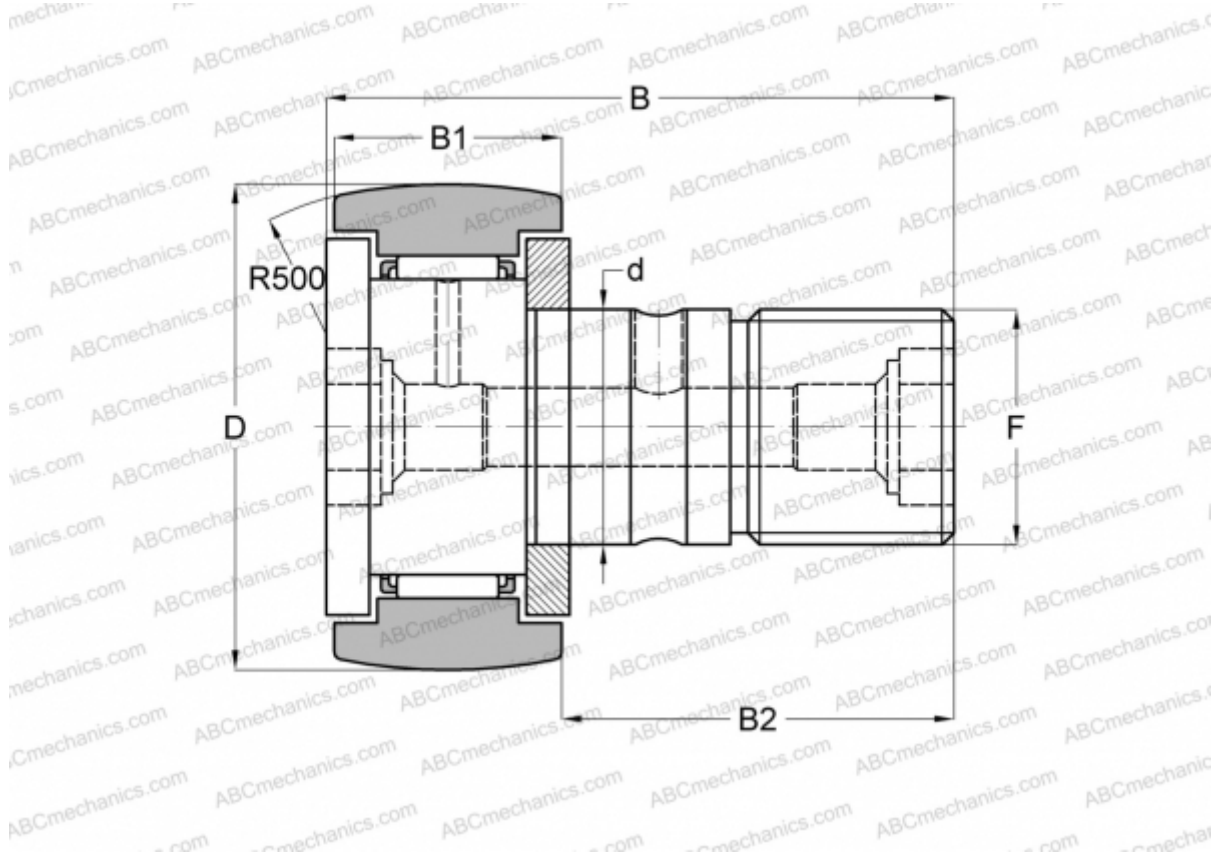

Technical specification

DIMENSIONS, MM

d	11,112
D	25,400
B	42,069
B1	16,669
B2	25,400
F	7/16-20

WEIGHT, KG 0,073

MANUFACTURER [IKO](#)

INTERCHANGE

ABC	CR 16 R
INA	CFC 16 Y

CALCULATION DATA

Basic dynamic load rating, C	8,810 kN
------------------------------	----------

CALCULATION DATA

Basic static load rating, Co	10,800 kN
------------------------------	-----------