

CR 20 R IKO

Cam followers

TYPE: Roller bearings, Stud type track rollers, With axial guidance, gap seals on both side, inch size

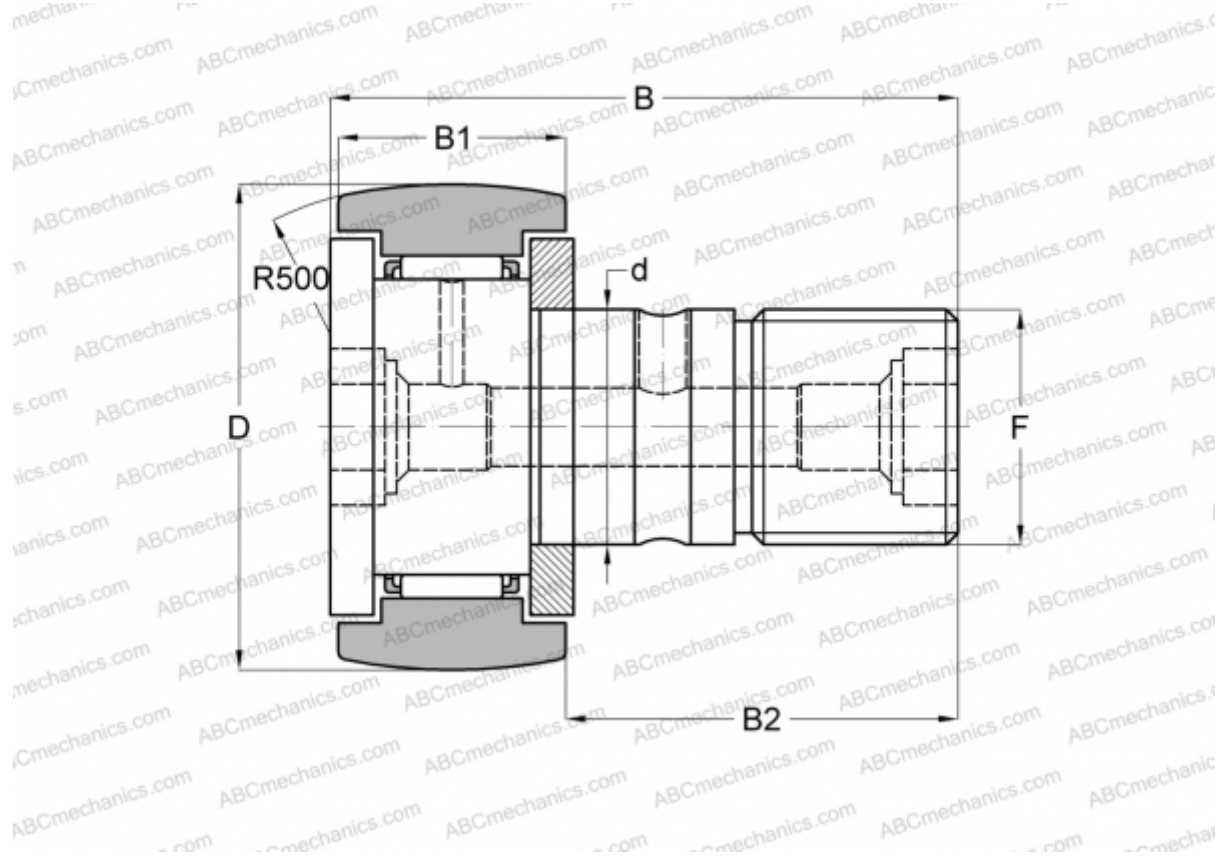

Technical specification

DIMENSIONS, MM

d	12,700
D	31,750
B	51,594
B1	19,844
B2	31,750
F	1/2-20

WEIGHT, KG 0,132

MANUFACTURER [IKO](#)

INTERCHANGE

ABC	CR 20 R
INA	CFC 20 Y

CALCULATION DATA

Basic dynamic load rating, C	14,200 kN
------------------------------	-----------

CALCULATION DATA

Basic static load rating, Co	16,000 kN
------------------------------	-----------