

CR 28 R IKO

Cam followers

TYPE: Roller bearings, Stud type track rollers, With axial guidance, gap seals on both side, inch size

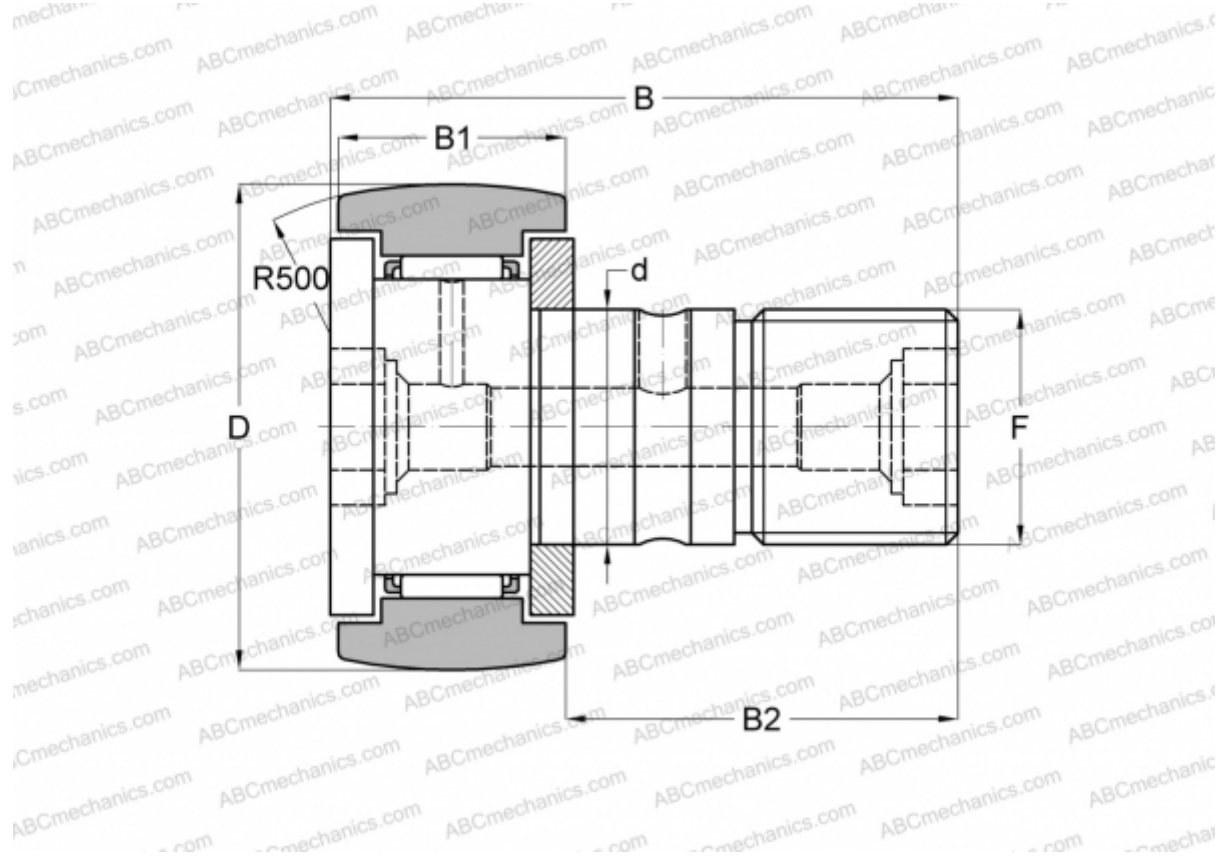

Technical specification

DIMENSIONS, MM

d	19,050
D	44,450
B	70,644
B1	26,194
B2	44,450
F	3/4-16

WEIGHT, KG 0,365

MANUFACTURER [IKO](#)

INTERCHANGE

ABC	CR 28 R
INA	CFC 28 Y

CALCULATION DATA

Basic dynamic load rating, C	25,100 kN
------------------------------	-----------

CALCULATION DATA

Basic static load rating, Co	38,200 kN
------------------------------	-----------