

CFC 18 INA

Cam followers

TYPE: Roller bearings, Stud type track rollers, With axial guidance, gap seals on both side, cylindrical outer ring, inch size

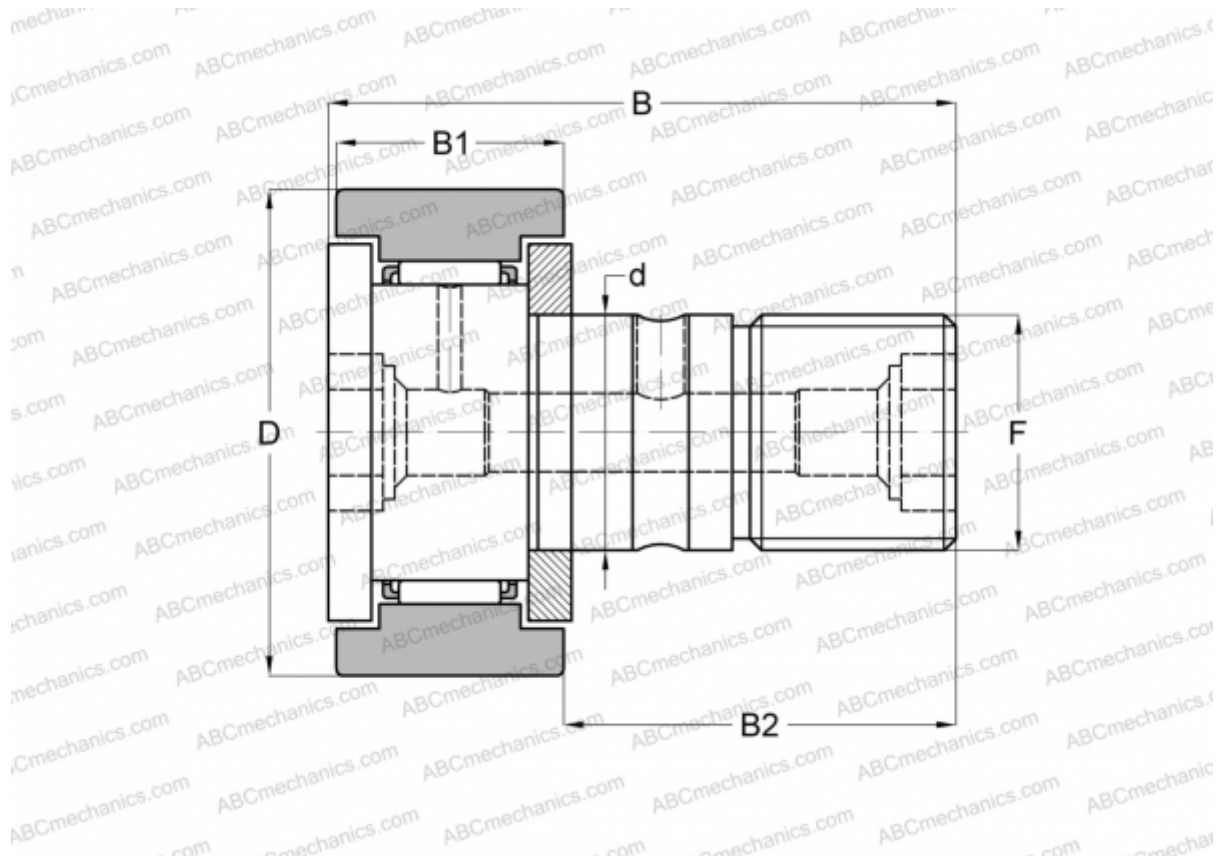

Technical specification

DIMENSIONS, MM

d	11,112
D	28,575
B	42,069
B1	16,669
B2	25,400
F	7/16-20

WEIGHT, KG 0,088

MANUFACTURER [INA](#)

INTERCHANGE

ABC	CR 18
IKO	CR 18