

CFC 36 INA

Cam followers

TYPE: Roller bearings, Stud type track rollers, With axial guidance, gap seals on both side, cylindrical outer ring, inch size

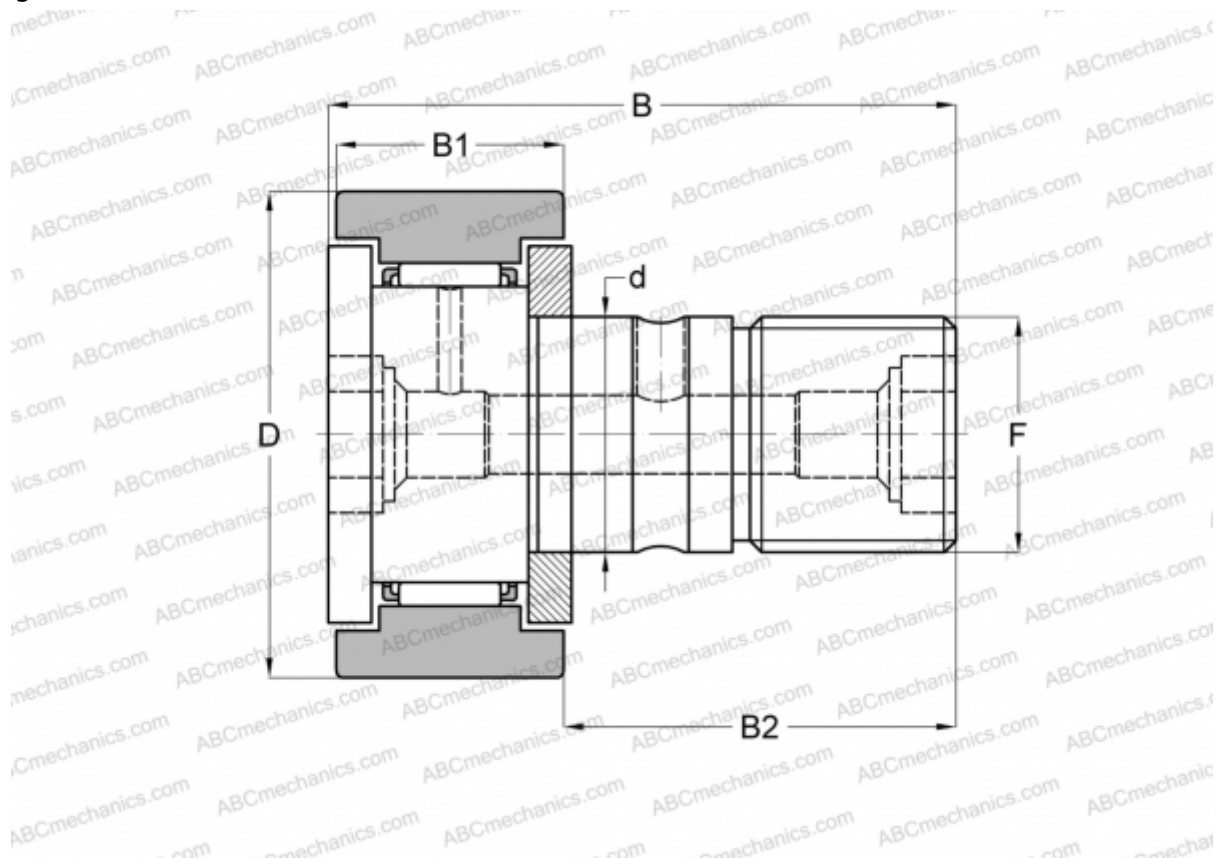

Technical specification

DIMENSIONS, MM

d	22,225
D	57,150
B	83,344
B1	32,544
B2	50,800
F	7/8-14

WEIGHT, KG 0,750

MANUFACTURER [INA](#)

INTERCHANGE

ABC	CR 36
IKO	CR 36