

## CR 12 BUUR ABC

Cam followers

TYPE: Roller bearings, Stud type track rollers, With axial guidance, sealing rings on both sides, hex socket, inch size

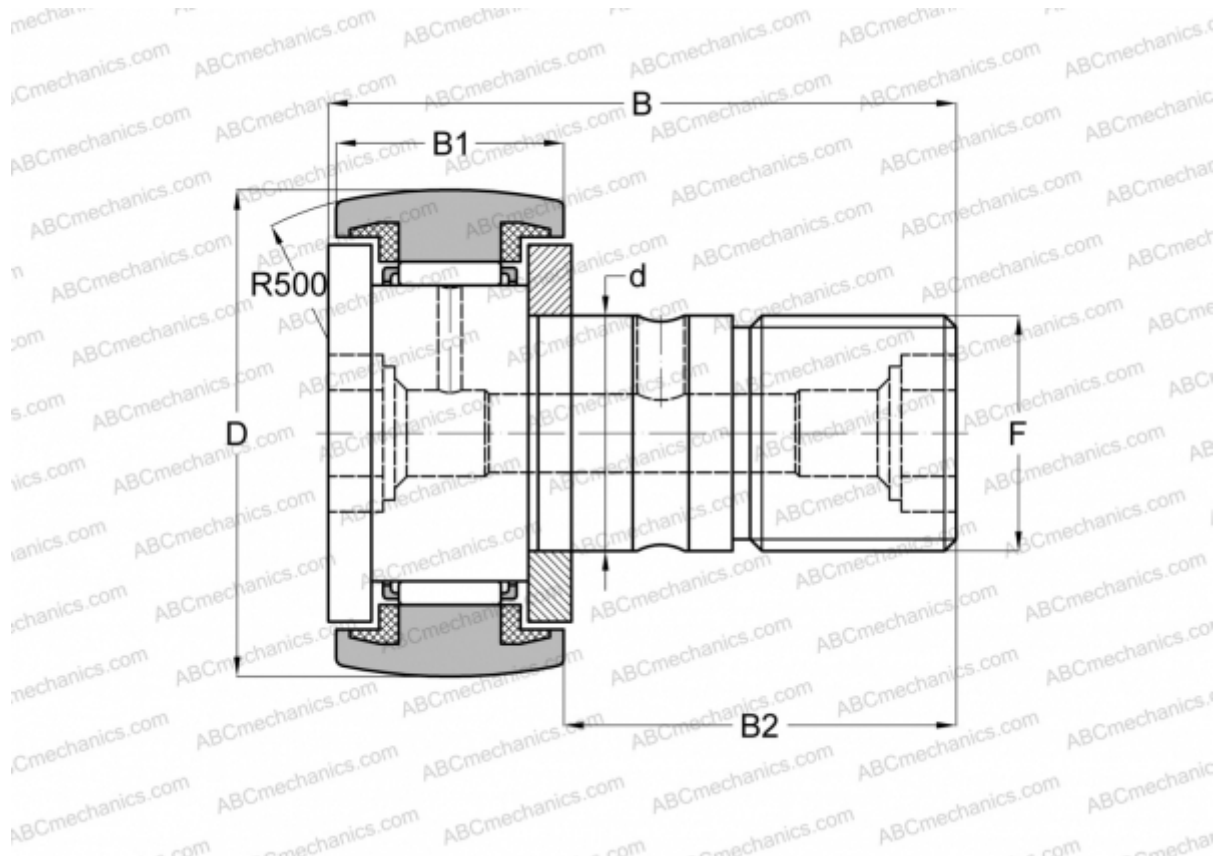

### Technical specification

#### DIMENSIONS, MM

d	9,525
D	19,050
B	35,719
B1	13,494
B2	22,225
C	3,000

**WEIGHT, KG** 0,035

**MANUFACTURER** [ABC](#)

#### INTERCHANGE

IKO	<a href="#">CR 12 BUUR</a>
INA	<a href="#">CFC 12 PPYSK</a>