

CFC 14 PPYSK INA

Cam followers

TYPE: Roller bearings, Stud type track rollers, With axial guidance, sealing rings on both sides, hex socket, inch size

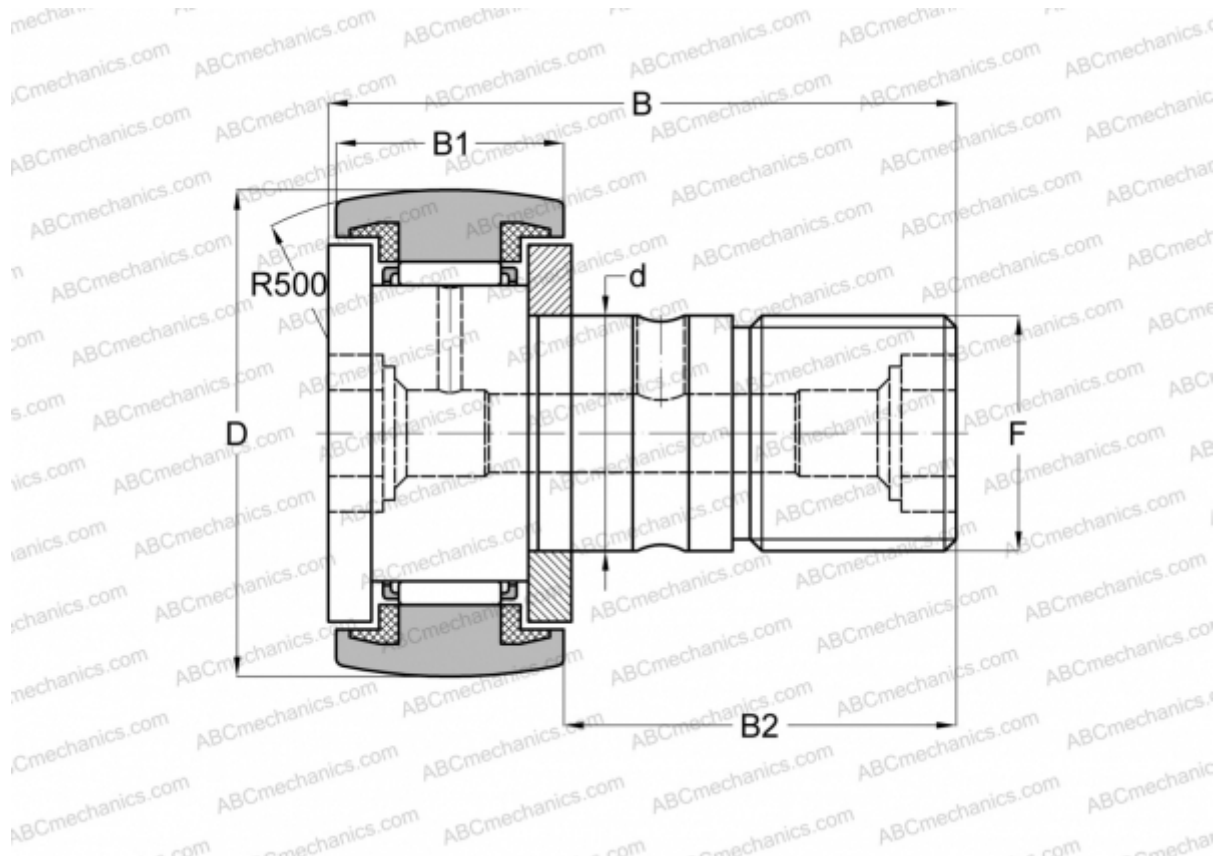

Technical specification

DIMENSIONS, MM

d	9,525
D	22,225
B	35,719
B1	13,494
B2	22,225
C	3,000

WEIGHT, KG 0,046

MANUFACTURER [INA](#)

INTERCHANGE

ABC	CR 14 BUUR
IKO	CR 14 BUUR