

CR 18 BUUR ABC

Cam followers

TYPE: Roller bearings, Stud type track rollers, With axial guidance, sealing rings on both sides, hex socket, inch size

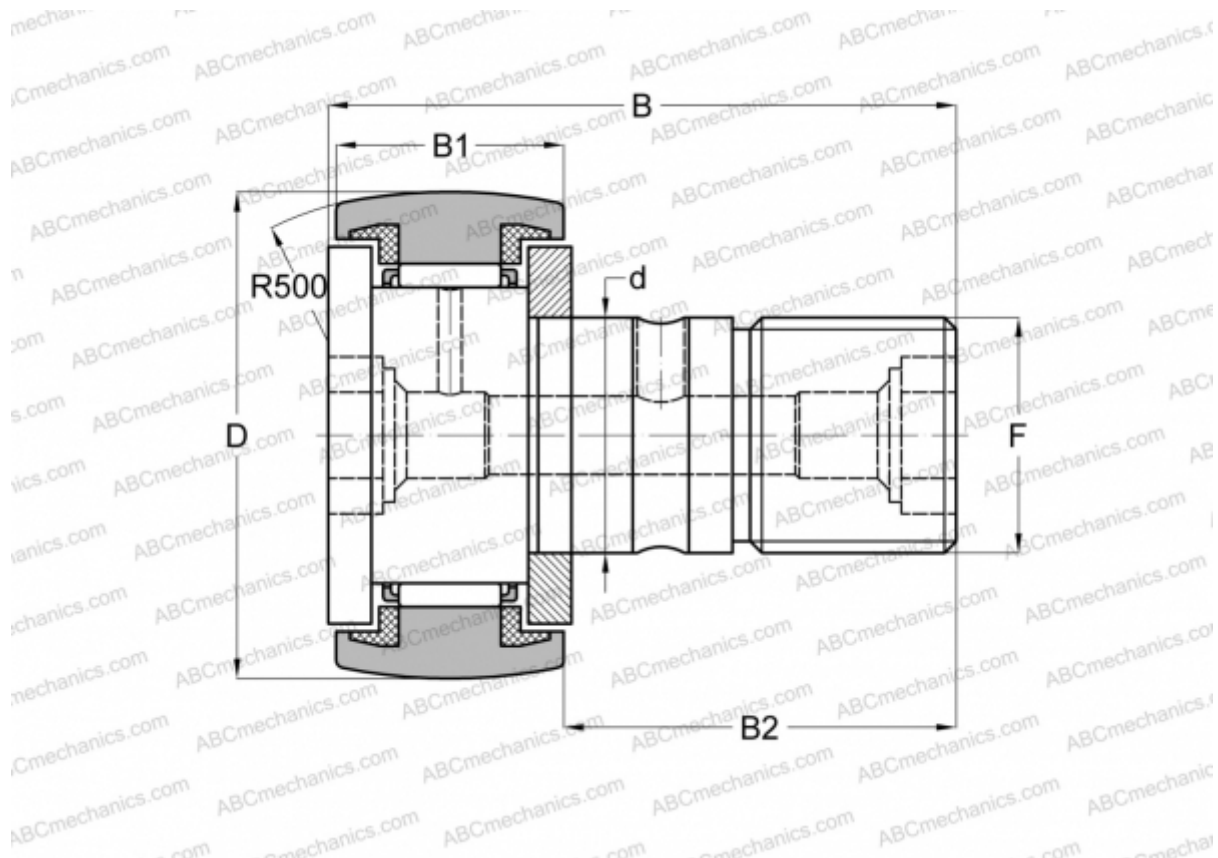

Technical specification

DIMENSIONS, MM

d	11,112
D	28,575
B	42,069
B1	16,669
B2	25,400
C	7,000

WEIGHT, KG 0,088

MANUFACTURER [ABC](#)

INTERCHANGE

IKO	CR 18 BUUR
INA	CFC 18 PPYSK