

CR 18 BUUR IKO

Cam followers

TYPE: Roller bearings, Stud type track rollers, With axial guidance, sealing rings on both sides, hex socket, inch size

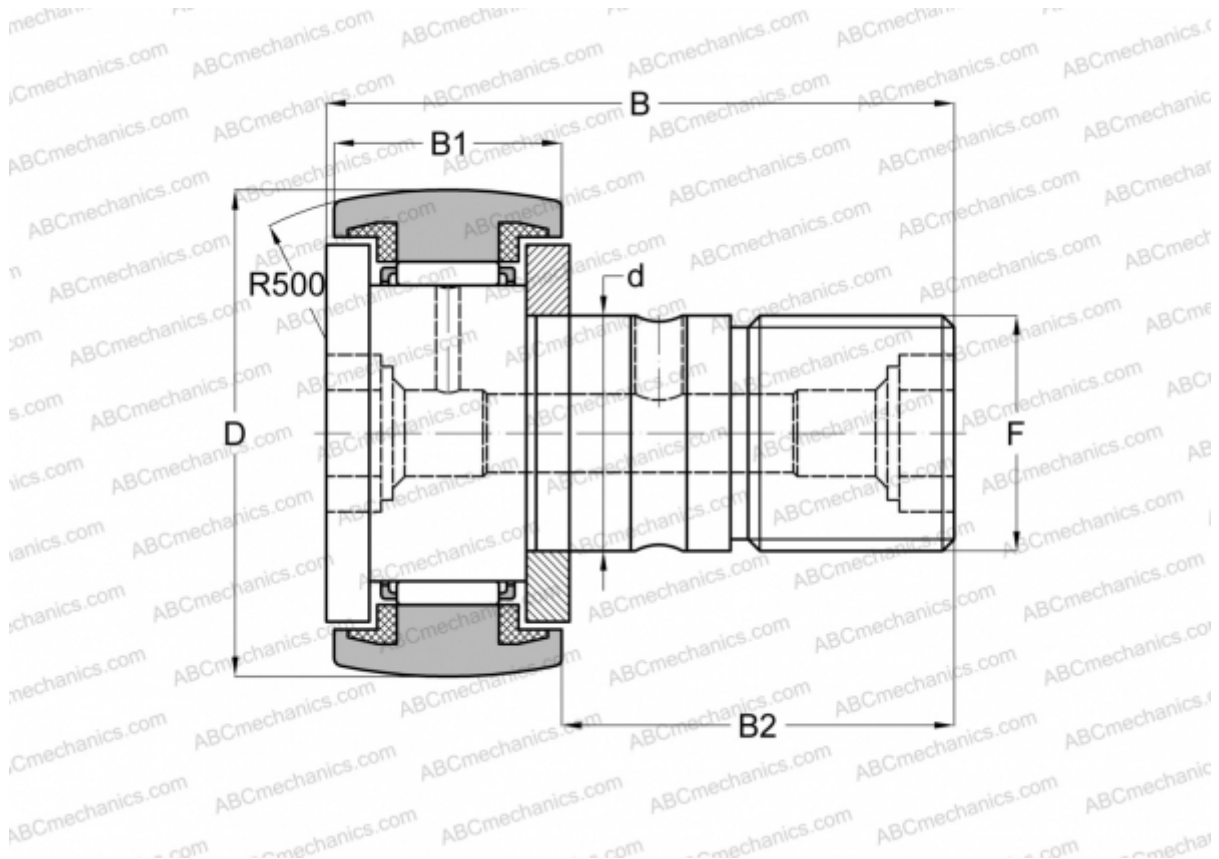

Technical specification

DIMENSIONS, MM

d	11,112
D	28,575
B	42,069
B1	16,669
B2	25,400
C	7,000

WEIGHT, KG 0,088

MANUFACTURER [IKO](#)

INTERCHANGE

ABC	CR 18 BUUR
INA	CFC 18 PPYSK

CALCULATION DATA

Basic dynamic load rating, C	9,180 kN
------------------------------	----------

CALCULATION DATA

Basic static load rating, Co	11,600 kN
------------------------------	-----------