

CR 22 BUUR ABC

Cam followers

TYPE: Roller bearings, Stud type track rollers, With axial guidance, sealing rings on both sides, hex socket, inch size

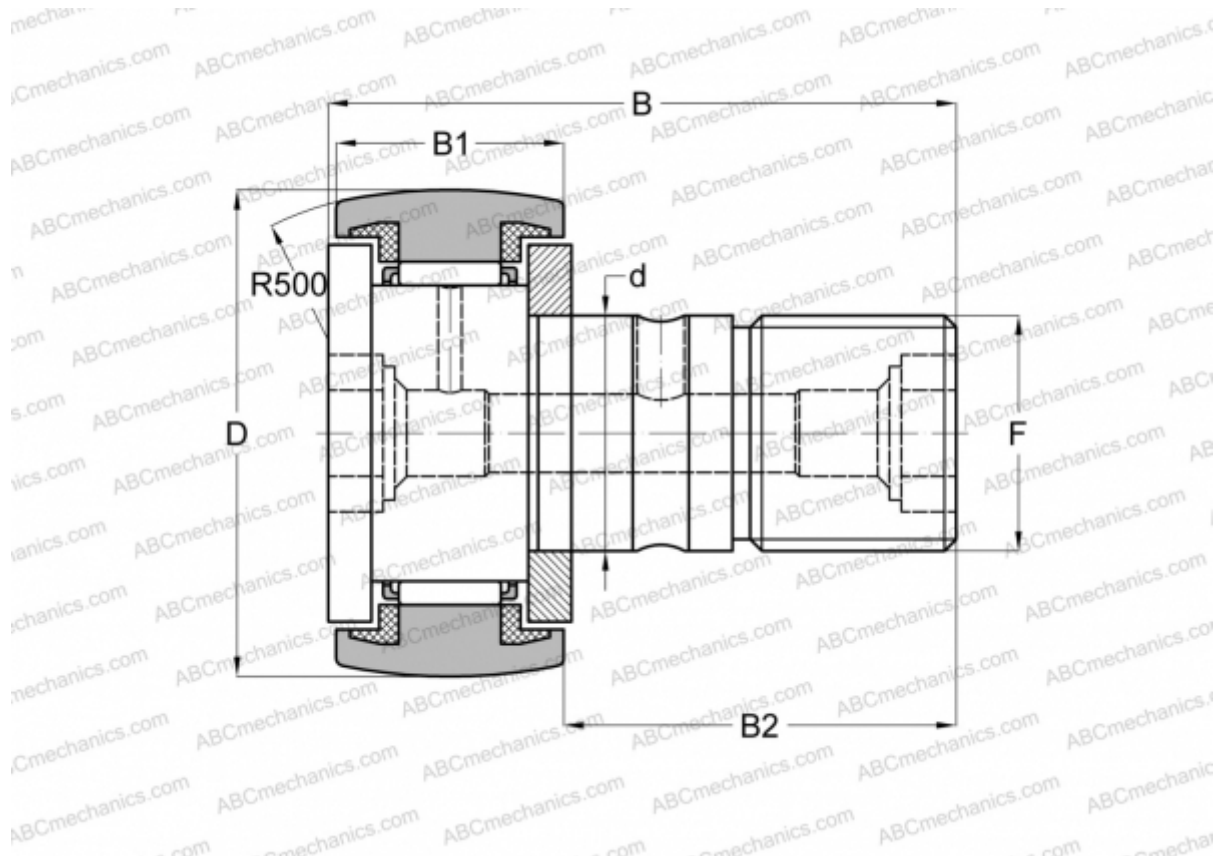

Technical specification

DIMENSIONS, MM

d	12,700
D	34,925
B	51,594
B1	19,844
B2	31,750
C	1,000

WEIGHT, KG 0,157

MANUFACTURER [ABC](#)

INTERCHANGE

IKO	CR 22 BUUR
INA	CFC 22 PPYSK