

CR 24 BUUR IKO

Cam followers

TYPE: Roller bearings, Stud type track rollers, With axial guidance, sealing rings on both sides, hex socket, inch size

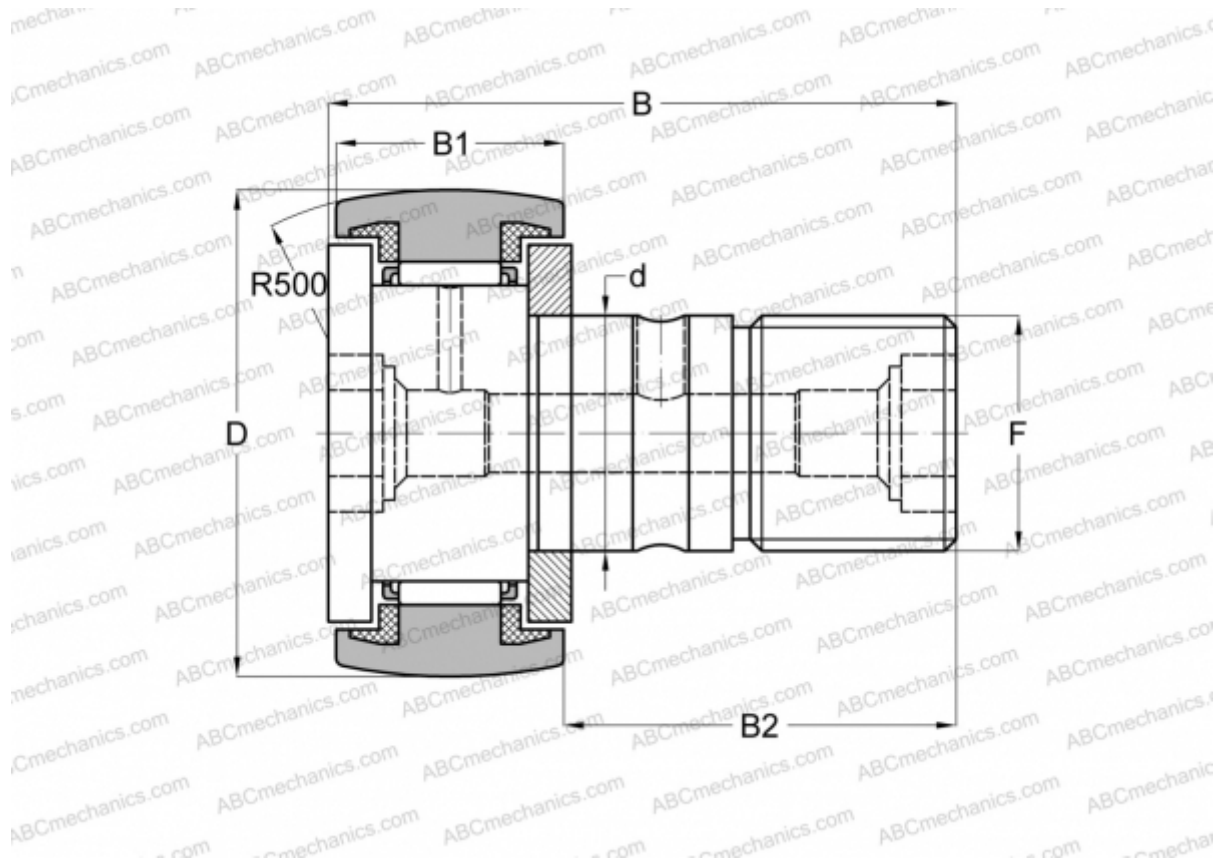

Technical specification

DIMENSIONS, MM

d	15,875
D	38,100
B	61,119
B1	23,019
B2	38,100
C	5,000

WEIGHT, KG 0,225

MANUFACTURER [IKO](#)

INTERCHANGE

ABC	CR 24 BUUR
INA	CFC 24 PPYSK

CALCULATION DATA

Basic dynamic load rating, C	18,600 kN
------------------------------	-----------

CALCULATION DATA

Basic static load rating, Co	24,300 kN
------------------------------	-----------