

CFC 24 PPYSK INA

Cam followers

TYPE: Roller bearings, Stud type track rollers, With axial guidance, sealing rings on both sides, hex socket, inch size

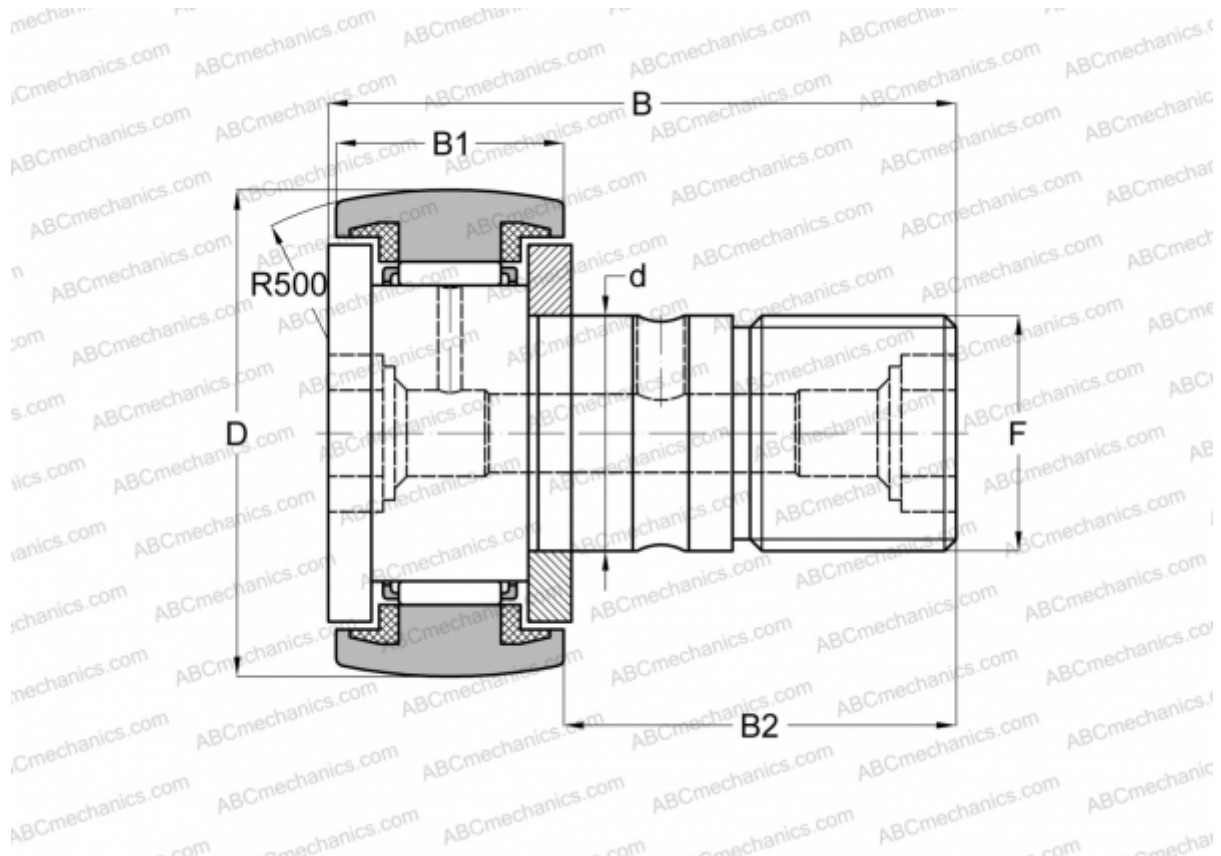

Technical specification

DIMENSIONS, MM

d	15,875
D	38,100
B	61,119
B1	23,019
B2	38,100
C	5,000

WEIGHT, KG 0,225

MANUFACTURER [INA](#)

INTERCHANGE

ABC	CR 24 BUUR
IKO	CR 24 BUUR