

## CR 30 BUUR ABC

Cam followers

TYPE: Roller bearings, Stud type track rollers, With axial guidance, sealing rings on both sides, hex socket, inch size

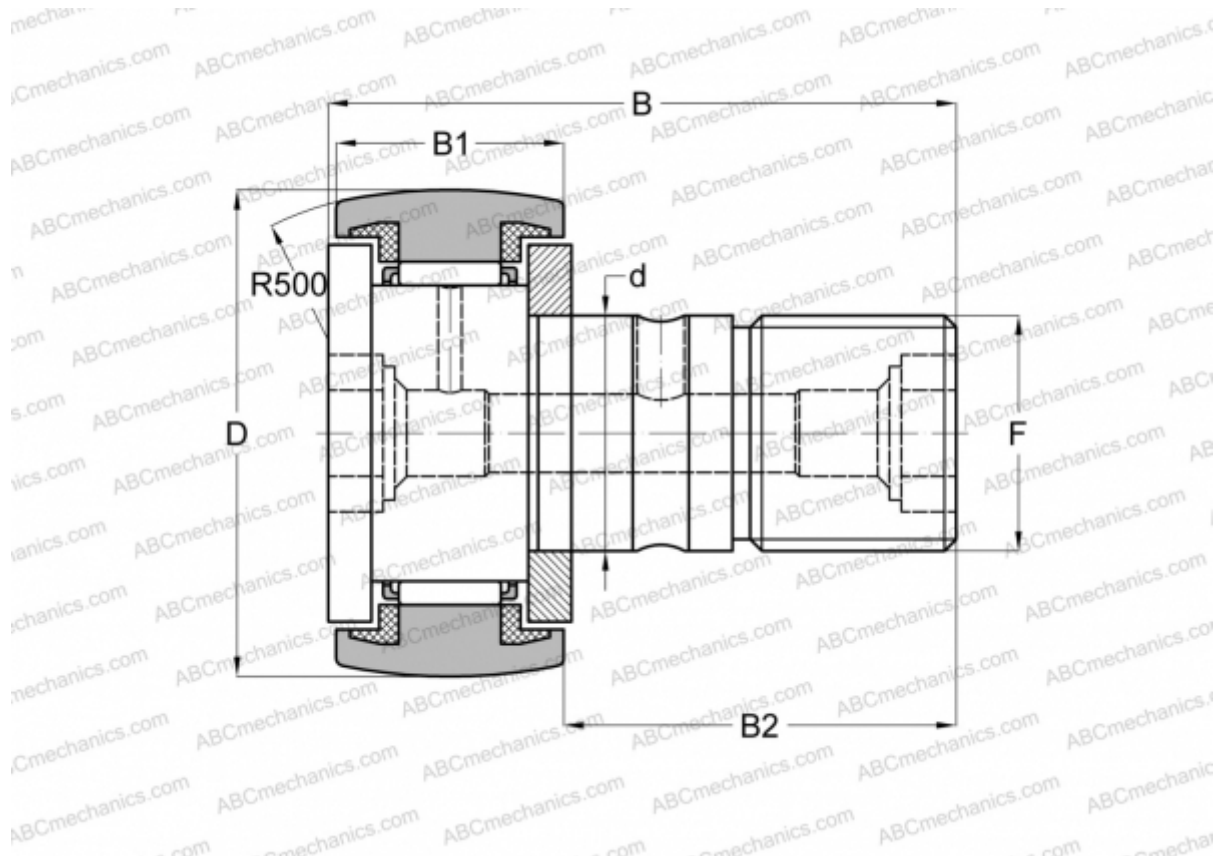

### Technical specification

#### DIMENSIONS, MM

d	19,050
D	47,625
B	70,644
B1	26,194
B2	44,450
C	3,000

**WEIGHT, KG** 0,410

**MANUFACTURER** [ABC](#)

#### INTERCHANGE

IKO	<a href="#">CR 30 BUUR</a>
INA	<a href="#">CFC 30 PPYSK</a>