

CR 30 BUUR IKO

Cam followers

TYPE: Roller bearings, Stud type track rollers, With axial guidance, sealing rings on both sides, hex socket, inch size

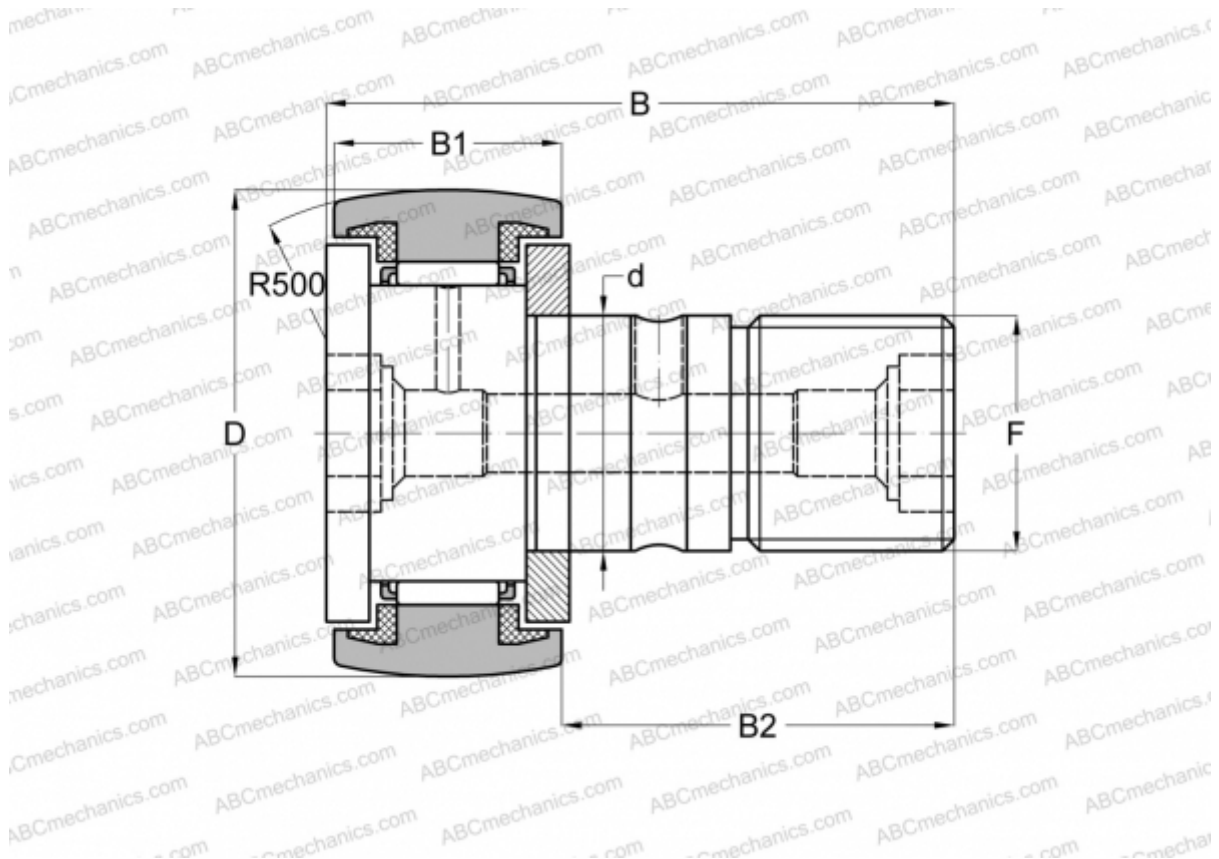

Technical specification

DIMENSIONS, MM

d	19,050
D	47,625
B	70,644
B1	26,194
B2	44,450
C	3,000

WEIGHT, KG 0,410

MANUFACTURER [IKO](#)

INTERCHANGE

ABC	CR 30 BUUR
INA	CFC 30 PPYSK

CALCULATION DATA

Basic dynamic load rating, C	25,100 kN
------------------------------	-----------

CALCULATION DATA

Basic static load rating, Co	38,200 kN
------------------------------	-----------