

CR 32 BUUR ABC

Cam followers

TYPE: Roller bearings, Stud type track rollers, With axial guidance, sealing rings on both sides, hex socket, inch size

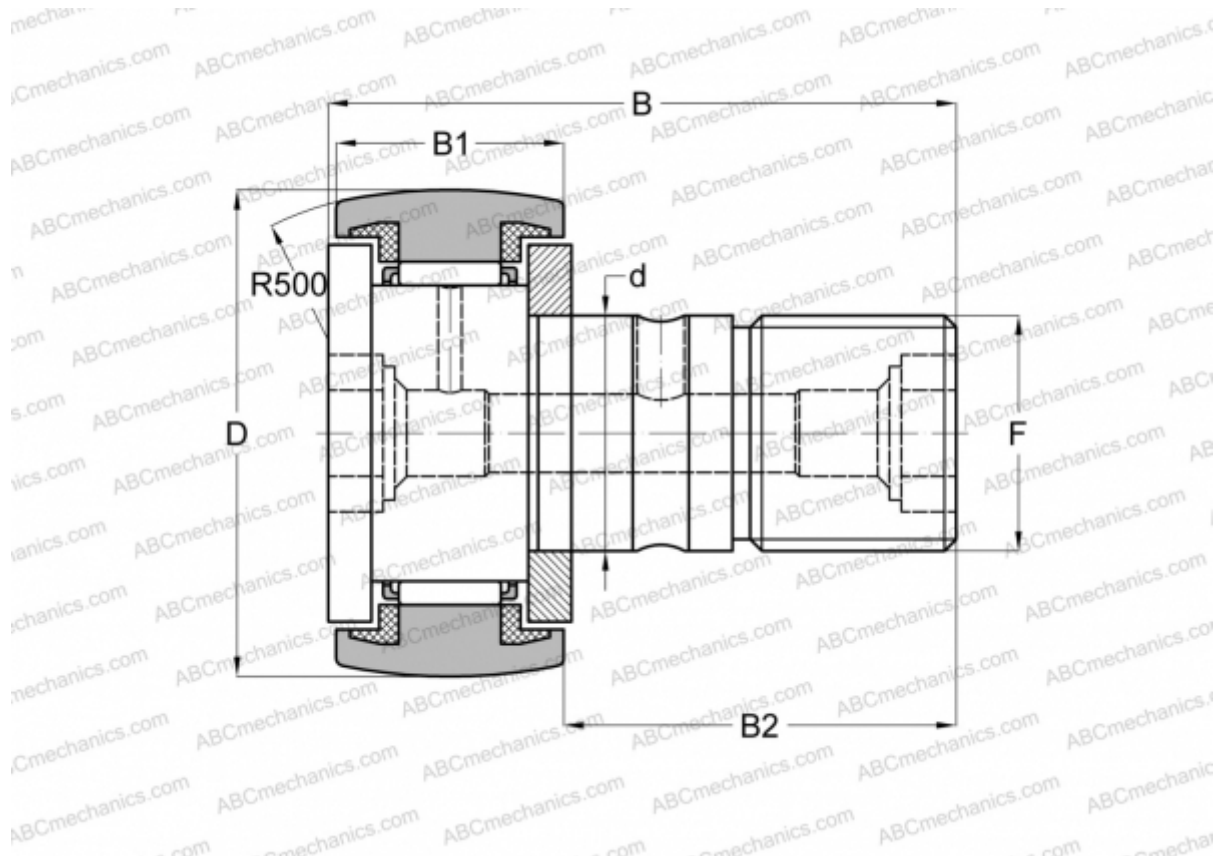

Technical specification

DIMENSIONS, MM

d	22,225
D	50,800
B	83,344
B1	32,544
B2	50,800
C	7,000

WEIGHT, KG 0,615

MANUFACTURER [ABC](#)

INTERCHANGE

IKO	CR 32 BUUR
INA	CFC 32 PPYSK