

CR 36 BUUR IKO

Cam followers

TYPE: Roller bearings, Stud type track rollers, With axial guidance, sealing rings on both sides, hex socket, inch size

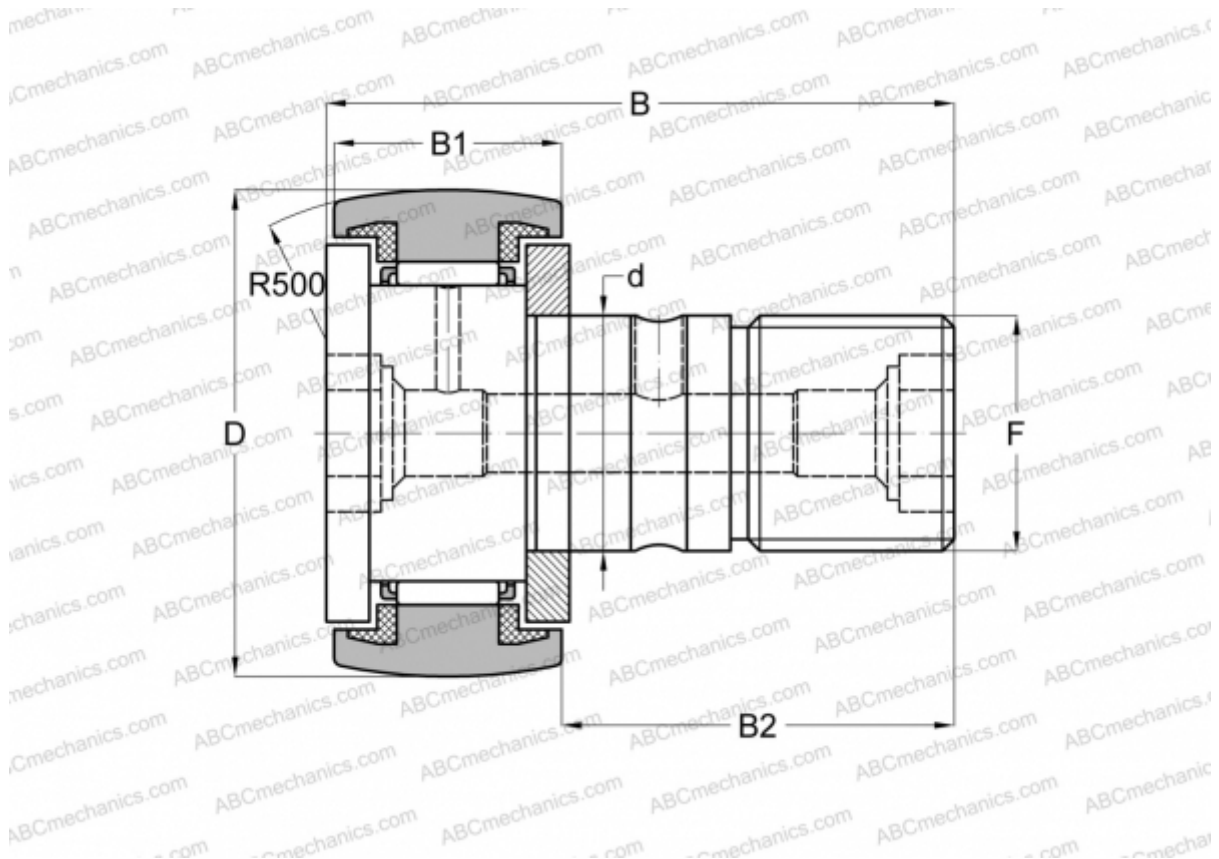

Technical specification

DIMENSIONS, MM

d	22,225
D	57,150
B	83,344
B1	32,544
B2	50,800
C	7,000

WEIGHT, KG 0,750

MANUFACTURER [IKO](#)

INTERCHANGE

ABC	CR 36 BUUR
INA	CFC 36 PPYSK

CALCULATION DATA

Basic dynamic load rating, C	32,500 kN
------------------------------	-----------

CALCULATION DATA

Basic static load rating, Co	63,900 kN
------------------------------	-----------