

## CFC 36 PPYSK INA

Cam followers

TYPE: Roller bearings, Stud type track rollers, With axial guidance, sealing rings on both sides, hex socket, inch size

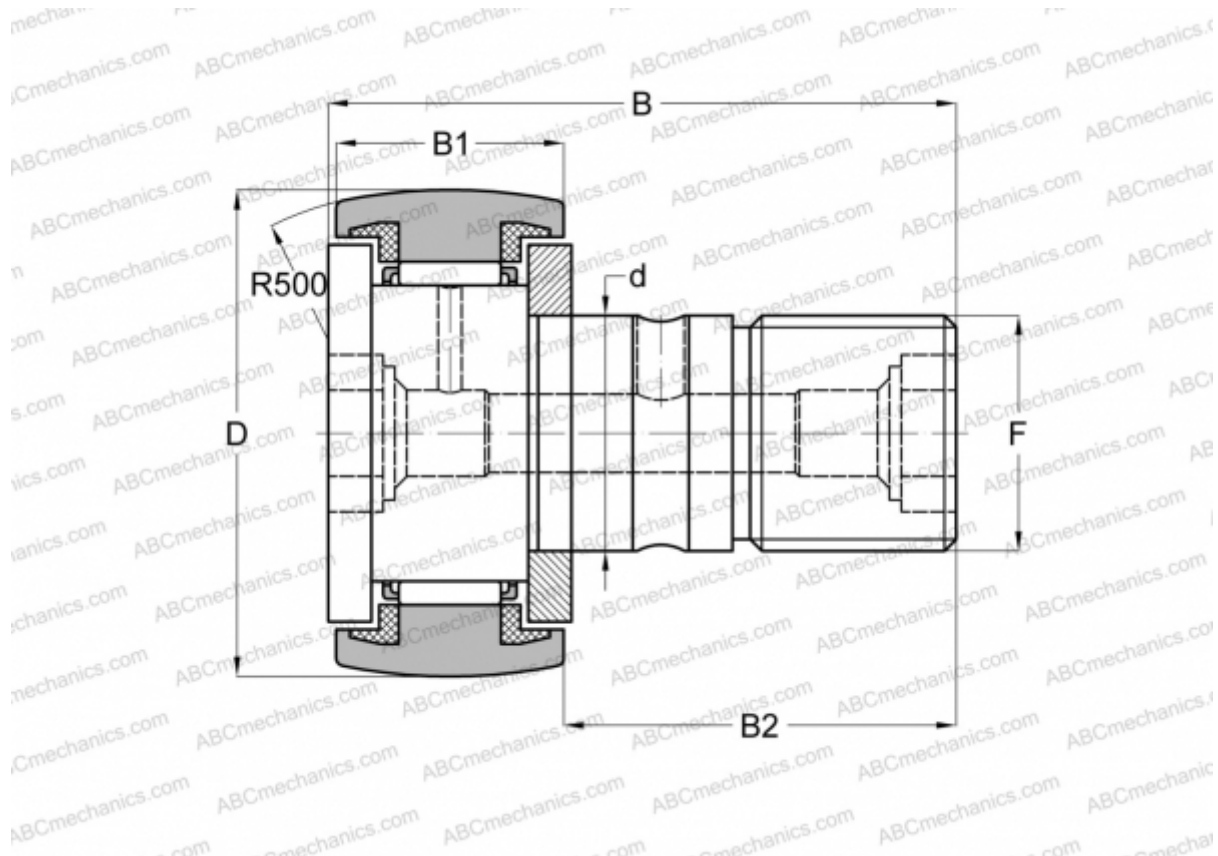

### Technical specification

#### DIMENSIONS, MM

d	22,225
D	57,150
B	83,344
B1	32,544
B2	50,800
C	7,000

**WEIGHT, KG** 0,750

**MANUFACTURER** [INA](#)

#### INTERCHANGE

ABC	<a href="#">CR 36 BUUR</a>
IKO	<a href="#">CR 36 BUUR</a>