

CR 36 BUU ABC

Cam followers

TYPE: Roller bearings, Stud type track rollers, With axial guidance, sealing rings on both sides, cylindrical outer ring, hex socket, inch size

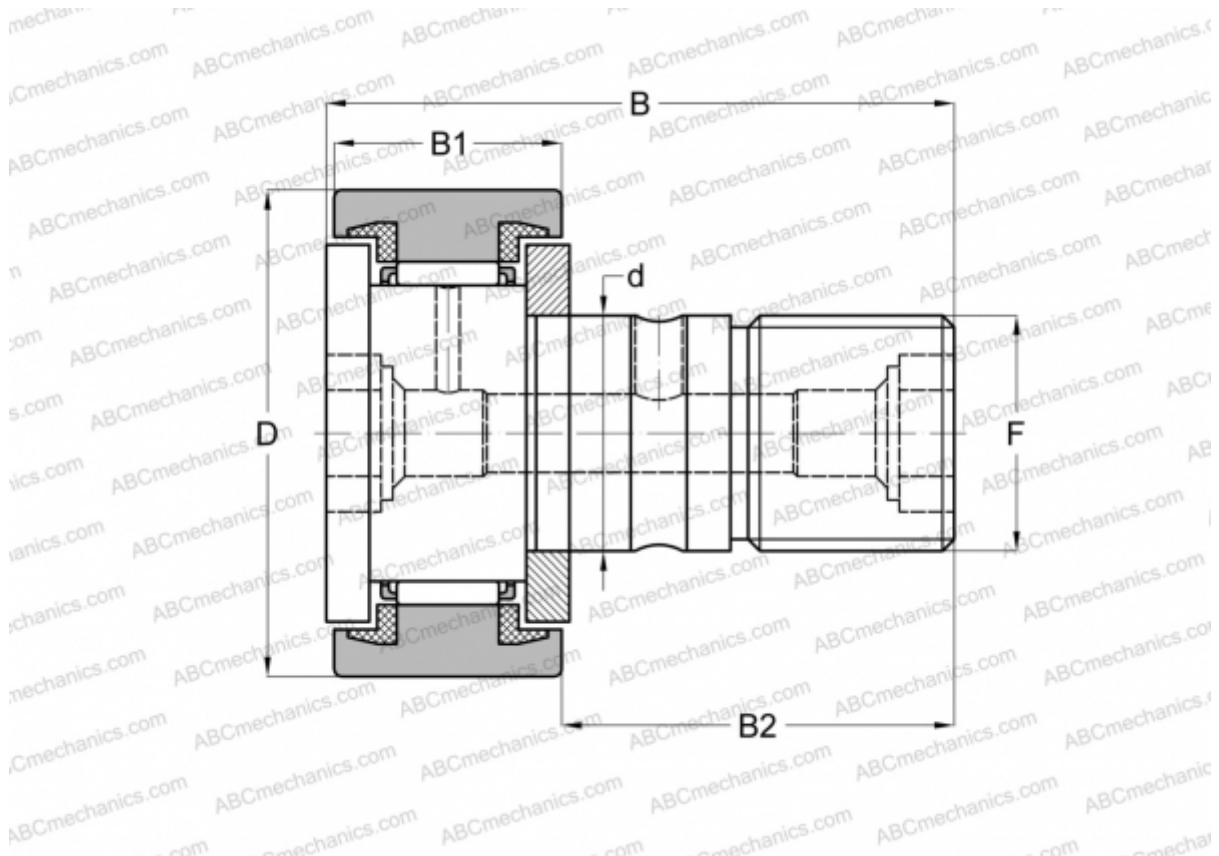

Technical specification

DIMENSIONS, MM

d	22,225
D	57,150
B	83,344
B1	32,544
B2	50,800
C	7,000

WEIGHT, KG 0,750

MANUFACTURER [ABC](#)

INTERCHANGE

IKO	CR 36 BUU
INA	CFC 36 PPSK