

## CFC 14 PP INA

Cam followers

TYPE: Roller bearings, Stud type track rollers, With axial guidance, sealing rings on both sides, cylindrical outer ring, inch size

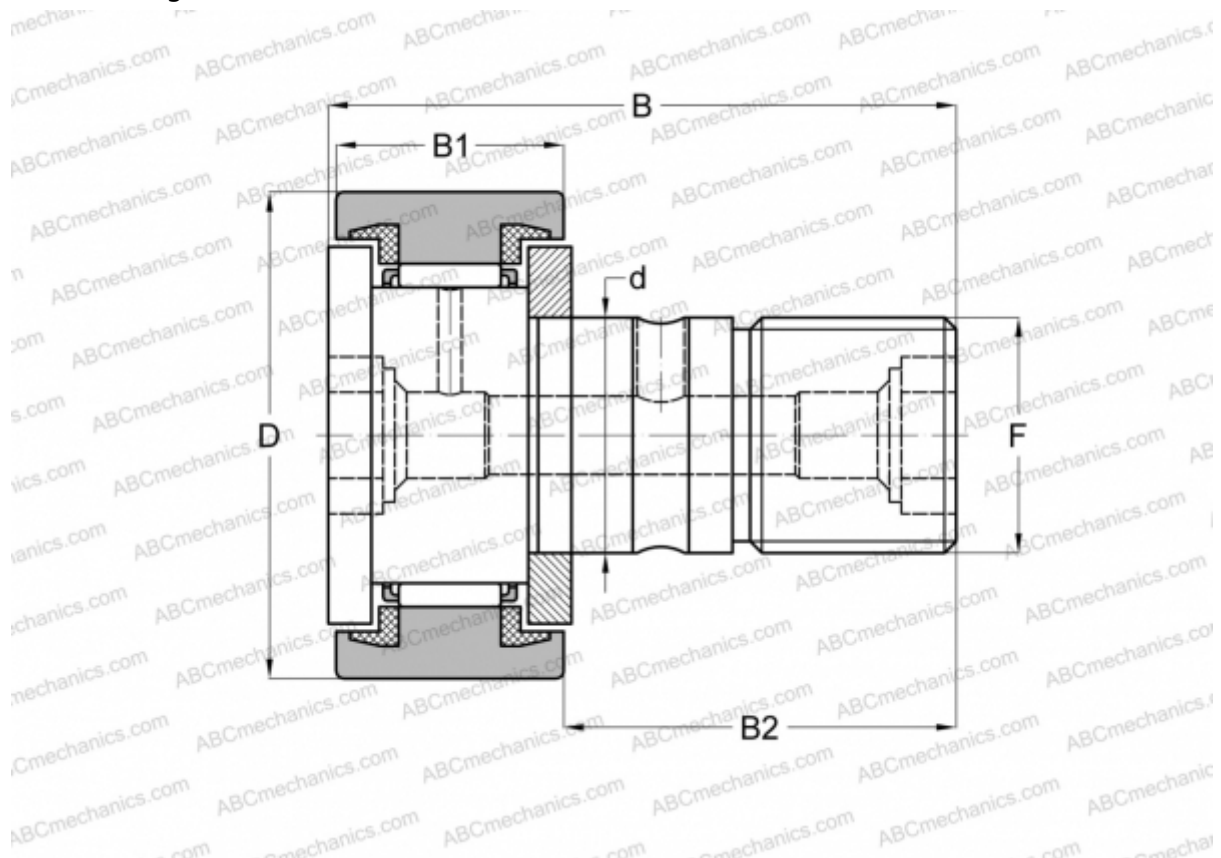

### Technical specification

#### DIMENSIONS, MM

d	9,525
D	22,225
B	35,719
B1	13,494
B2	22,225
F	3/8-24

**WEIGHT, KG** 0,046

**MANUFACTURER** [INA](#)

#### INTERCHANGE

ABC	<a href="#">CR 14 UU</a>
IKO	<a href="#">CR 14 UU</a>