

## CFC 16 PP INA

Cam followers

TYPE: Roller bearings, Stud type track rollers, With axial guidance, sealing rings on both sides, cylindrical outer ring, inch size

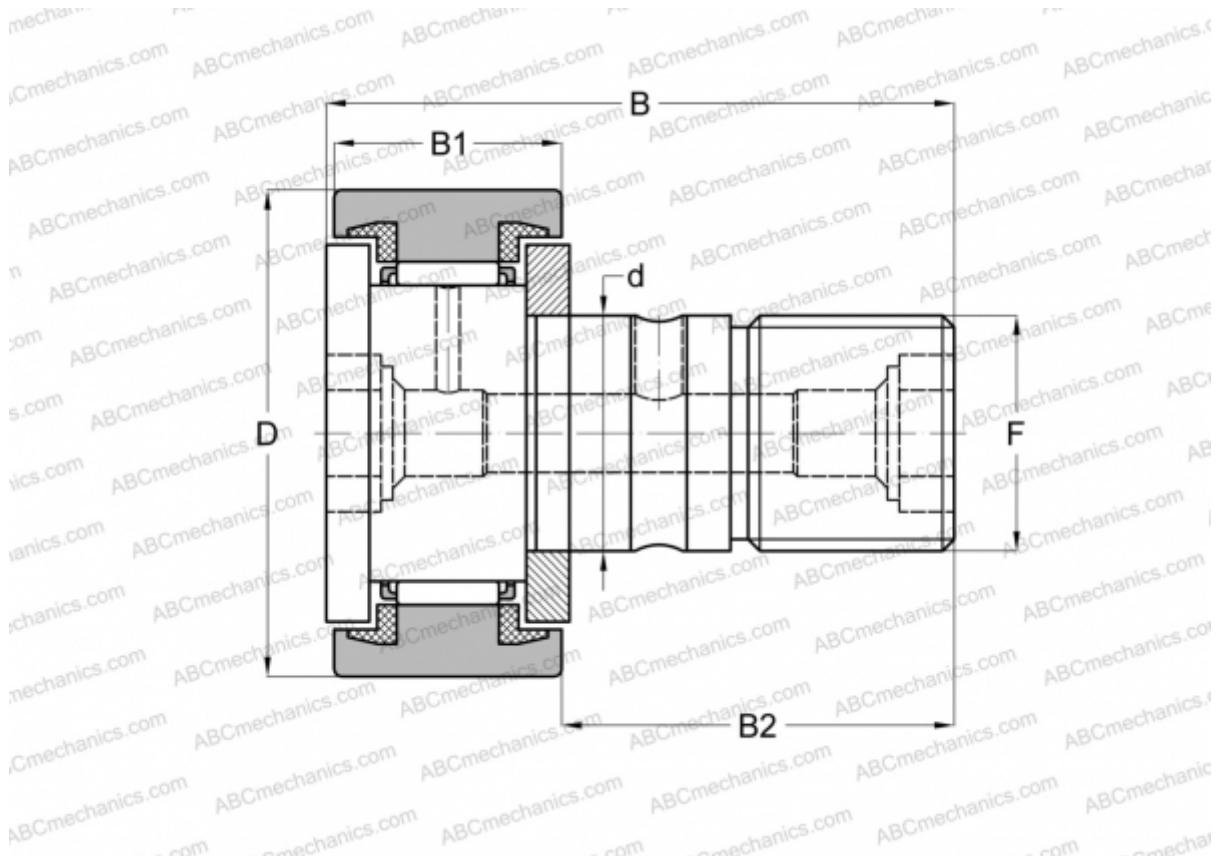

### Technical specification

#### DIMENSIONS, MM

d	11,112
D	25,400
B	42,069
B1	16,669
B2	25,400
F	7/16-20

**WEIGHT, KG** 0,073

**MANUFACTURER** [INA](#)

#### INTERCHANGE

ABC	<a href="#">CR 16 UU</a>
IKO	<a href="#">CR 16 UU</a>