

CR 22 UU IKO

Cam followers

TYPE: Roller bearings, Stud type track rollers, With axial guidance, sealing rings on both sides, cylindrical outer ring, inch size

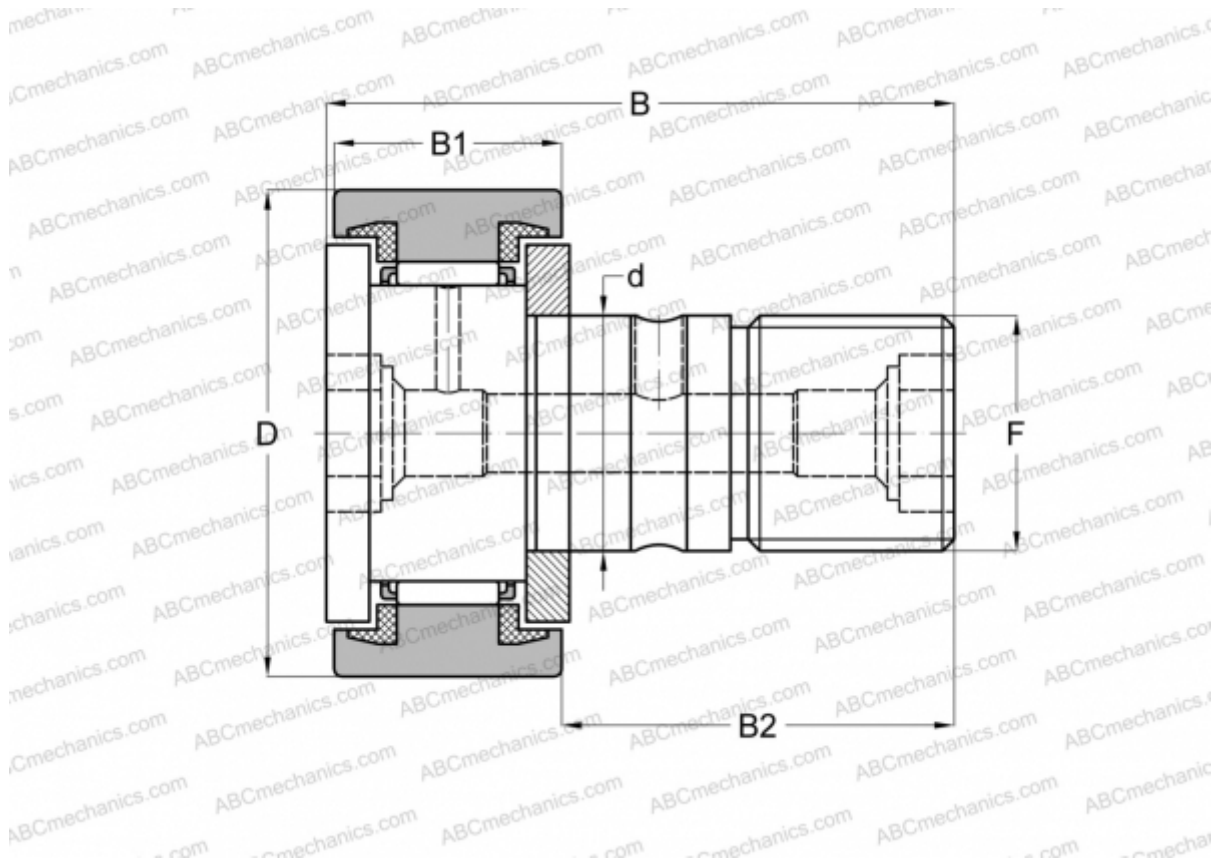

Technical specification

DIMENSIONS, MM

d	12,700
D	34,925
B	51,594
B1	19,844
B2	31,750
F	1/2-20

WEIGHT, KG 0,157

MANUFACTURER [IKO](#)

INTERCHANGE

ABC	CR 22 UU
INA	CFC 22 PP

CALCULATION DATA

Basic dynamic load rating, C	14,200 kN
------------------------------	-----------

CALCULATION DATA

Basic static load rating, Co	16,000 kN
------------------------------	-----------