

CR 24 UU ABC

Cam followers

TYPE: Roller bearings, Stud type track rollers, With axial guidance, sealing rings on both sides, cylindrical outer ring, inch size

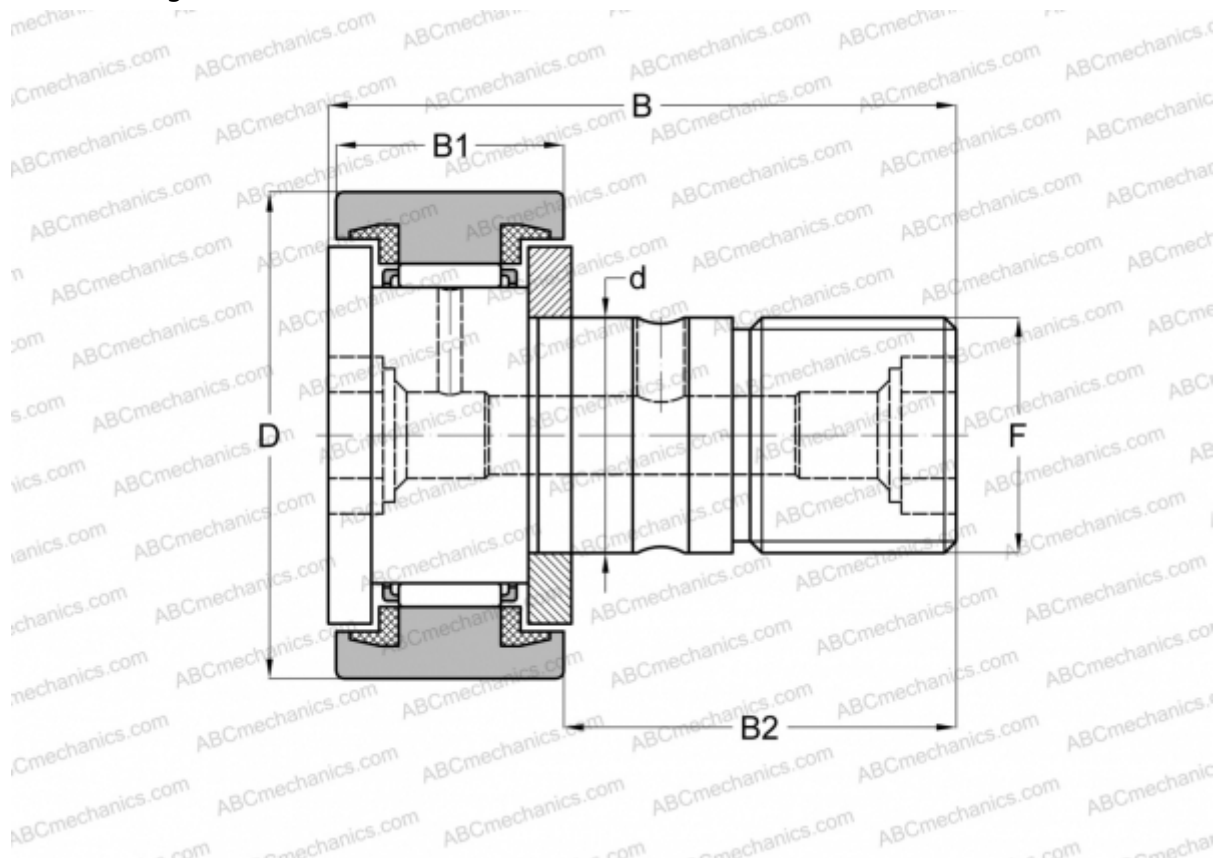

Technical specification

DIMENSIONS, MM

d	15,875
D	38,100
B	61,119
B1	23,019
B2	38,100
F	5/8-18

WEIGHT, KG 0,225

MANUFACTURER [ABC](#)

INTERCHANGE

IKO	CR 24 UU
INA	CFC 24 PP