

CFC 26 PP INA

Cam followers

TYPE: Roller bearings, Stud type track rollers, With axial guidance, sealing rings on both sides, cylindrical outer ring, inch size

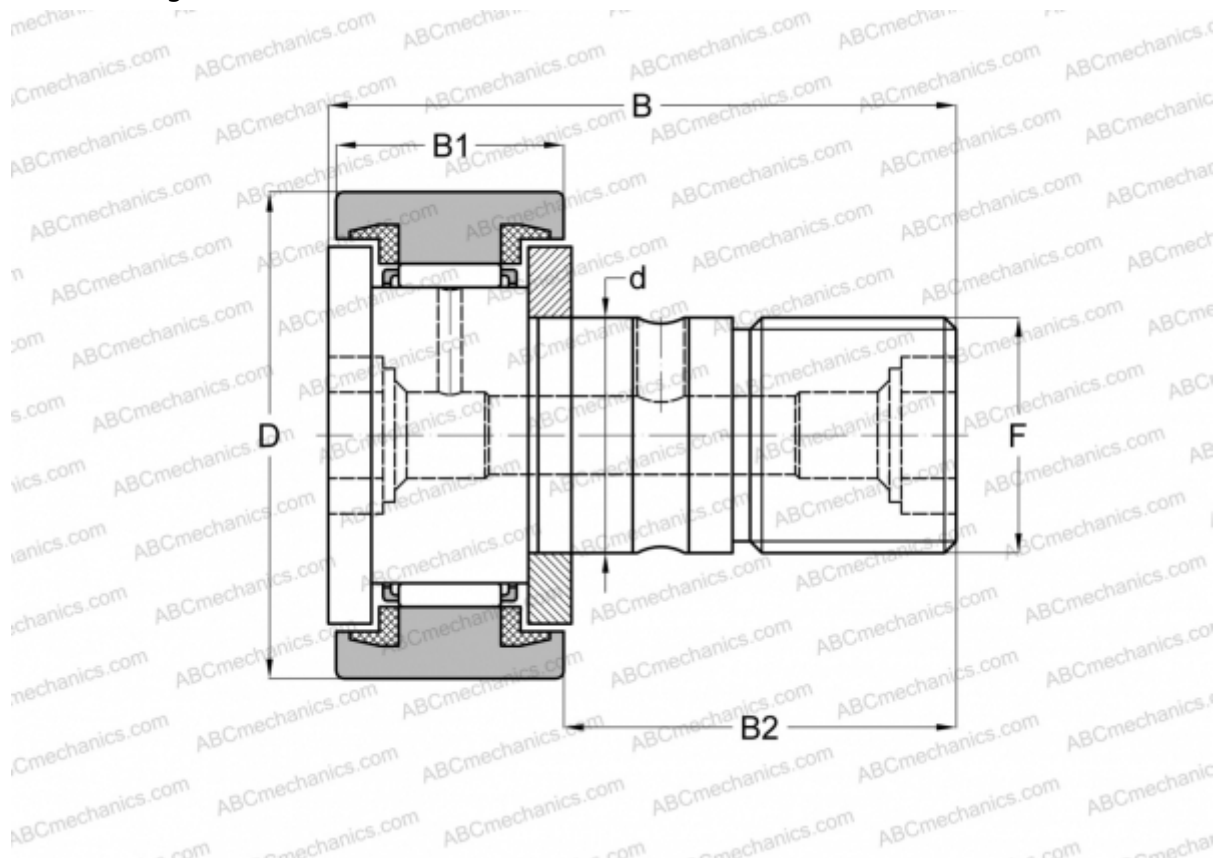

Technical specification

DIMENSIONS, MM

d	15,875
D	41,275
B	61,119
B1	23,019
B2	38,100
F	5/8-18

WEIGHT, KG 0,260

MANUFACTURER [INA](#)

INTERCHANGE

ABC	CR 26 UU
IKO	CR 26 UU