

CR 28 UU ABC

Cam followers

TYPE: Roller bearings, Stud type track rollers, With axial guidance, sealing rings on both sides, cylindrical outer ring, inch size

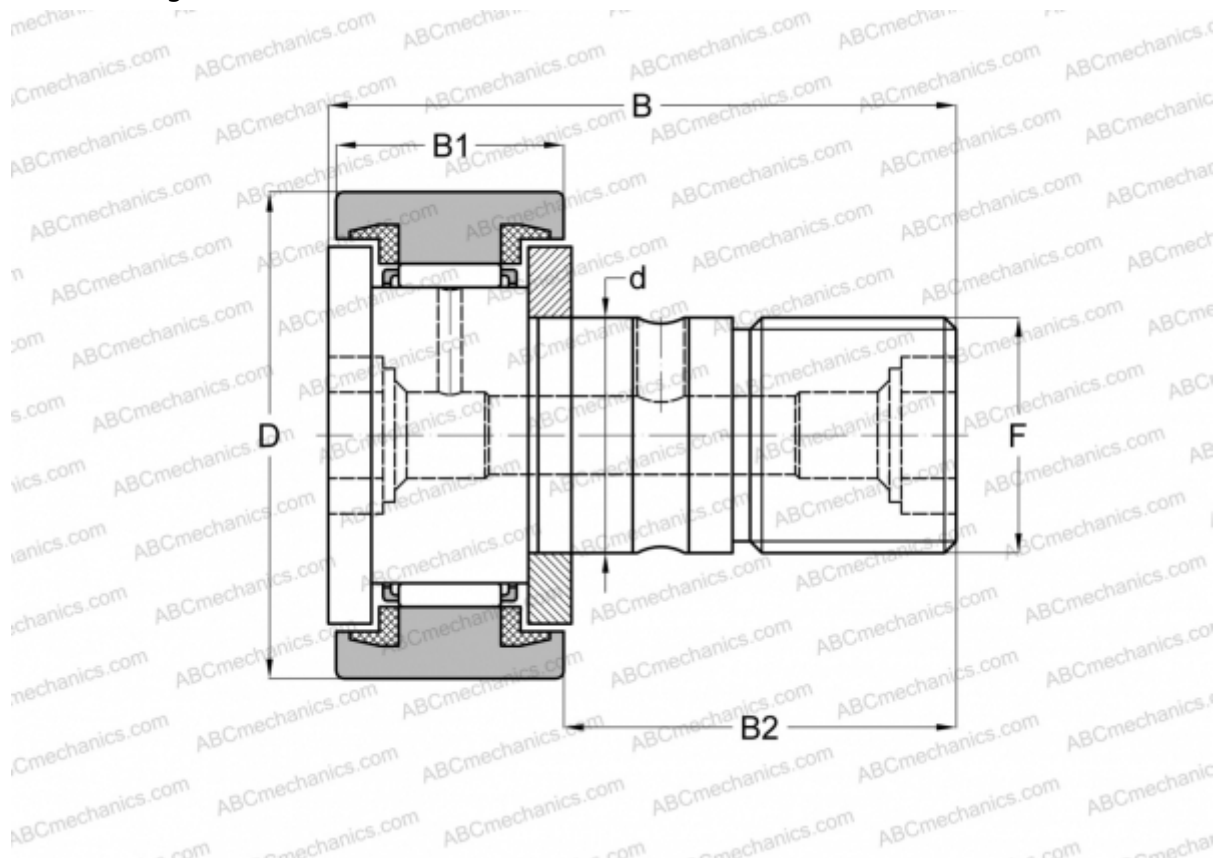

Technical specification

DIMENSIONS, MM

d	19,050
D	44,450
B	70,644
B1	26,194
B2	44,450
F	3/4-16

WEIGHT, KG 0,365

MANUFACTURER [ABC](#)

INTERCHANGE

IKO	CR 28 UU
INA	CFC 28 PP