

CFC 30 PP INA

Cam followers

TYPE: Roller bearings, Stud type track rollers, With axial guidance, sealing rings on both sides, cylindrical outer ring, inch size

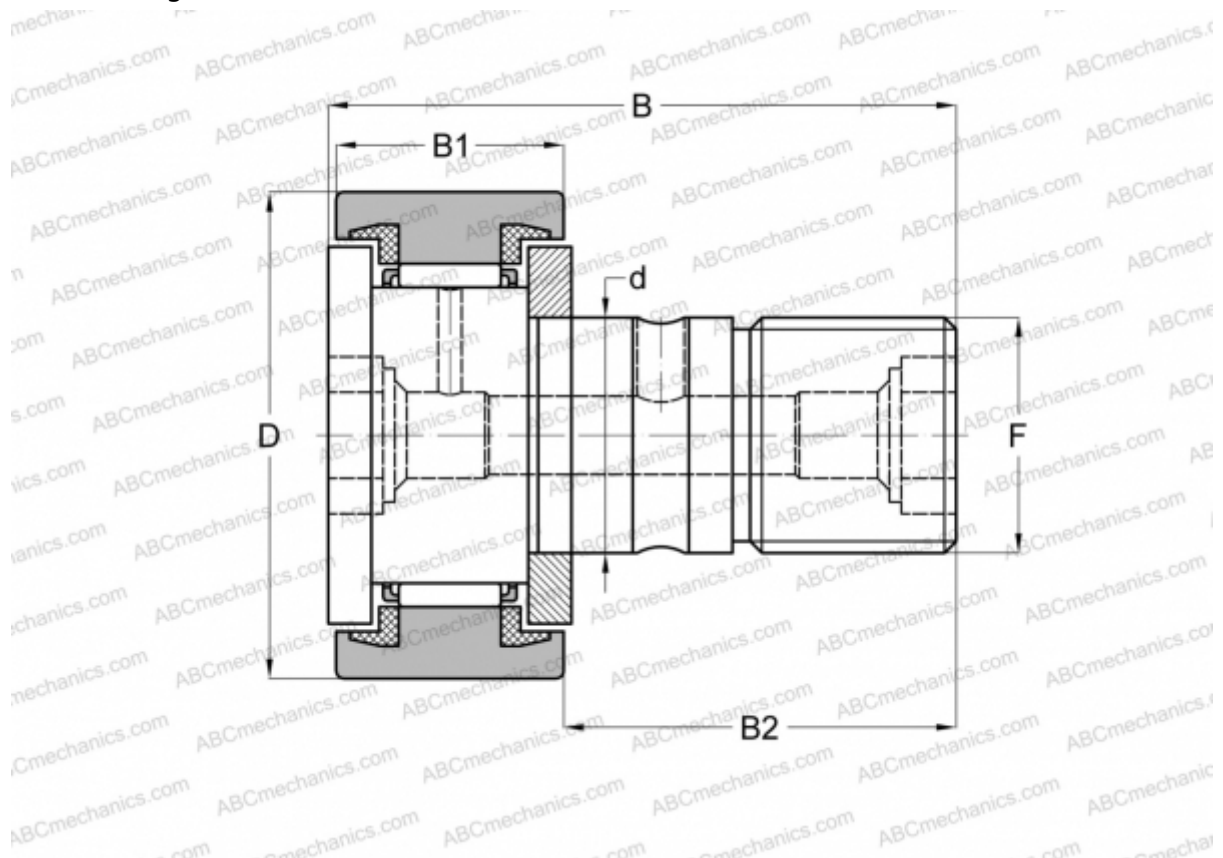

Technical specification

DIMENSIONS, MM

d	19,050
D	47,625
B	70,644
B1	26,194
B2	44,450
F	3/4-16

WEIGHT, KG 0,410

MANUFACTURER [INA](#)

INTERCHANGE

ABC	CR 30 UU
IKO	CR 30 UU