

## CFC 32 PP INA

Cam followers

TYPE: Roller bearings, Stud type track rollers, With axial guidance, sealing rings on both sides, cylindrical outer ring, inch size

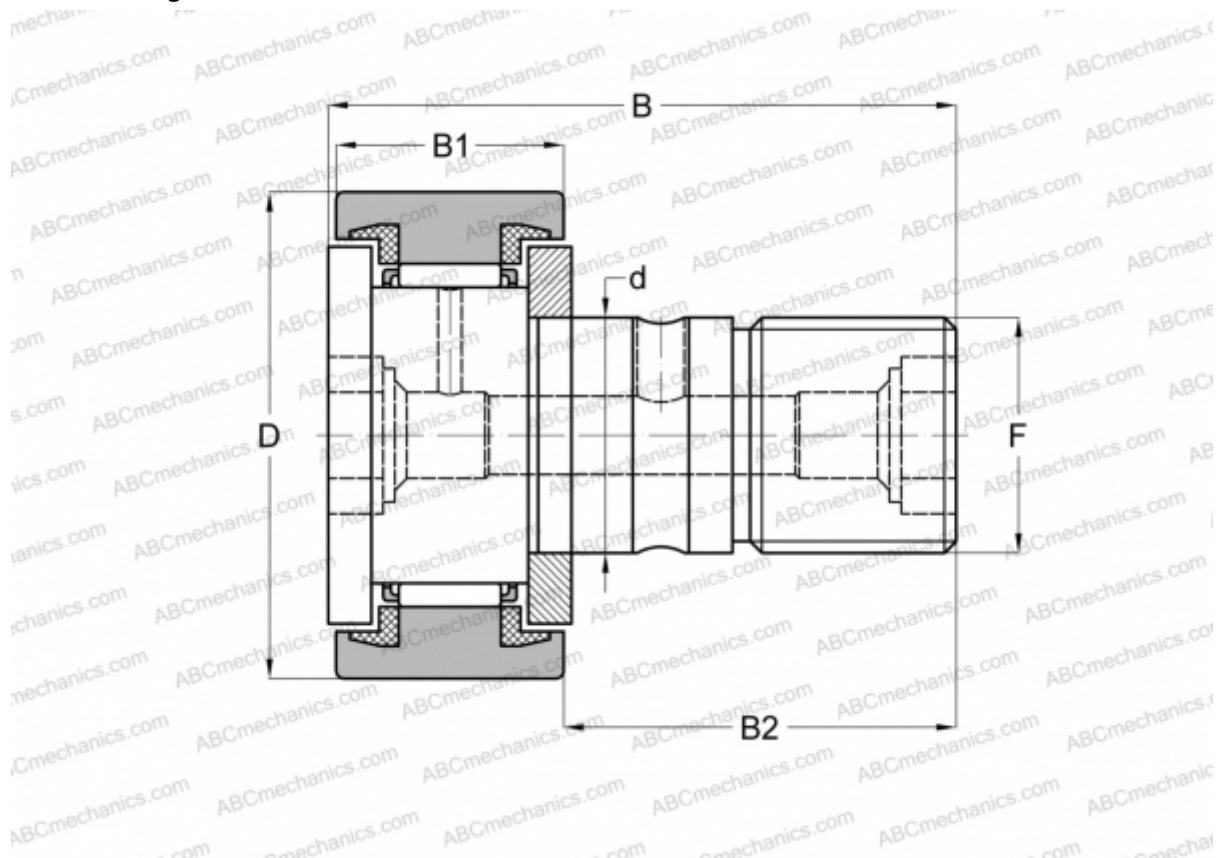

### Technical specification

#### DIMENSIONS, MM

d	22,225
D	50,800
B	83,344
B1	32,544
B2	50,800
F	7/8-14

**WEIGHT, KG** 0,615

**MANUFACTURER** [INA](#)

#### INTERCHANGE

ABC	<a href="#">CR 32 UU</a>
IKO	<a href="#">CR 32 UU</a>