

CR 30 VBR IKO

Cam followers

TYPE: Roller bearings, Stud type track rollers, With axial guidance, full complement bearing, gap seal on both side, hex socket, inch size

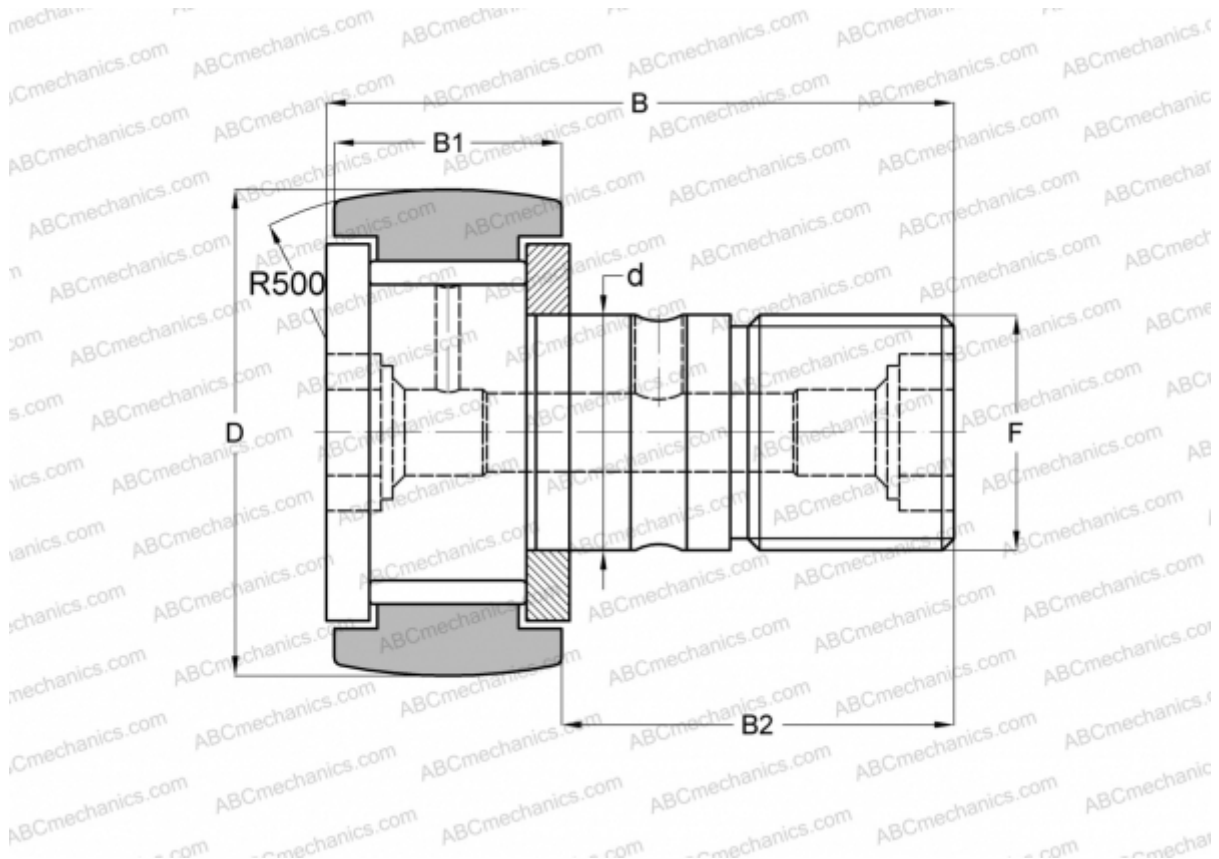

Technical specification

DIMENSIONS, MM

d	19,050
D	47,625
B	70,644
B1	26,194
B2	44,450
F	3/4-16

WEIGHT, KG 0,410

MANUFACTURER [IKO](#)

INTERCHANGE

ABC	CR 30 VBR
TORRINGTON	CRBC-30
INA	CF 30 YSK
McGill	CCF-1 7/8-B

CALCULATION DATA

Basic dynamic load rating, C	35,300 kN
Basic static load rating, Co	55,600 kN